

101400S01 SIGNAGE– Identifying Devices

General Guideline

The University of Kentucky Interior Sign standard is developed to address the need for a cost effective, functional, flexible and serviceable sign system. To review the General University of Kentucky Campus Signage Policy, please consult <https://www.uky.edu/Graphics/SignagePolicy.pdf>. This policy includes Identification signage for buildings, facilities, venues, and directories; Way-finding signage; Regulatory signage for vehicular, bicycle and pedestrian movement, parking, etc.; and Temporary signage for events, announcements, etc. The intent is to assure code compliance, consistency and visual effectiveness of all signs on the campus.

Interior signs are an extension of the exterior sign system and their content and design should take this into consideration.

NOTE: If a department/college replaces ADA compliant signage with non-ADA compliant signage your department/college will be back charged to bring the signage back into compliance.

Hospital Signage is to be coordinated with UK Hospital Planning for conformity across all Hospital Pavilions. All other signage should be procured through either LC-PPD or MC-PPD.

Signs included under this standard are:

1.0 - Directories

2.0 - Maps

3.0 - Room Identification Signage (Includes all rooms plus stairwell #'s and elevator #'s)

- 3.1 – Basic Room Number Sign
- 3.2 – Restroom Identification Signage
- 3.3 – Offices, Conference Rooms, Departments

4.0 - Directional Signs (Includes signage in stairwells indicating floor level at each landing)

- 4.1 – Basic Directional Signage – Stairs
- 4.2 – Corridor Directional Signs

5.0 - Laboratory Signs

- 5.1 – Basic Laboratory Signage
- 5.2 – Laboratory Bench Signage

6.0 - Regulatory Signage

- 6.1 – Exit Signs
- 6.2 – Emergency Evacuation Signs
- 6.3 – Room Occupancy Capacity Signs

7.0 - Room Signage Mounting Positions/Heights

- 7.1 – Room Sign installation for 'Single Door with Sign'
- 7.2 – Sign Installation Option for 'Exit Doors'
- 7.3 – Room Sign Installation for Doors with Small Sidelights
- 7.4 – Room Sign Installation for Doors with Large Sidelights

All signs must comply with current ADAAG Guidelines and KY Building Codes.

101400S01 SIGNAGE– Identifying Devices

- 7.5 – Room Sign Installation for Double Doors with Normally Inactive Leaf
- 7.6 – Room Sign Installation for Double Doors with Both Doors Active
- 7.7 – Room Sign Installation for Laboratory Doors

Signage for Capital / Physical Plant Renovation Projects

Signage is a required part of every project package. All projects are required to provide minimal signage for the functioning of a building, including:

- Building identification sign - At least one sign at the primary entrance to the building as approved by the University Architect.
- Interior/Wayfinding signs - [Minimally consists of ADA-compliant](#) room number signs, rest room signs, stair and elevator signs with appropriate pictograms. May also include ADA-compliant sign frames with room numbers and removable inserts for labeling rooms.

NOTE: If a department/college replaces ADA compliant signage with non-ADA compliant signage your department/college will be back charged to bring the signage back into compliance.

- Building directory - At least one directory at the primary entrance to serve the whole building.

Identify Special Needs Beyond the Basic Functional Signage as Soon as Possible

In many cases, campus buildings developed with Capital funds require more than the minimum as outlined above. For instance, in many cases new buildings require the following:

- A library will require special information and Wayfinding signs.
- A sports facility or theater will require section numbering and seat numbering systems.
- A multiple-occupant building may require additional directory boards and Wayfinding signs to assist future visitors through the building.
- A building that is architecturally complex may require more Wayfinding signs than a simple building.
- Facilities being planned as having “flexible space” characteristics may need more flexible signage than a standard classroom building.

Note: Landscape Office Partition: A landscape office cubicle that is hard wired for electric and communications, AND is assigned to one (1) FTE person as their normal working space, And whose walls are 42” or higher, then a room number is to be assigned and a room identification sign is to be provided. Other situations will be reviewed on a case by case basis by the Facilities Information Coordinator.

Work with the assigned Project Manager to ensure special sign needs are identified as items to be provided in the Capital / Physical Plant Renovation Project. If special sign needs are known and not accounted for, the cost to provide the signs may not be able to be paid for out of the general project funds. Make sure the project budget covers additional or special sign needs.

All signs must comply with current ADAAG Guidelines and KY Building Codes.

101400S01 SIGNAGE– Identifying Devices

This standard applies mainly to new construction and major renovation. Many campus buildings have well developed sign systems (University Hospital, Commonwealth Stadium) and these systems should be extended where it is appropriate to do so while keeping within the established signage system aesthetics. Minor / Major renovation projects should make an attempt to move towards this standard whenever it is practical to do so.

Directories

All buildings should have directories keyed to a floor plan graphic(s) placed in a prominent location(s) where major decisions regarding movement/circulation are made, i.e. entrance points, lobbies, elevators. The language and organization of the directories should relate to the exterior signs. The Directory should include the room numbers, room occupants and room functions within buildings used by a college or department.



Mounting per manufacturers specifications. No plastic anchors allowed.

All signs must comply with current ADAAG Guidelines and KY Building Codes.

101400S01 SIGNAGE– Identifying Devices

Maps

Maps and building floor plans showing location of building wings, college and department destinations, accessible building elements, and restrooms. Larger, more complex buildings may require zoning to be color coded to aid in Wayfinding.

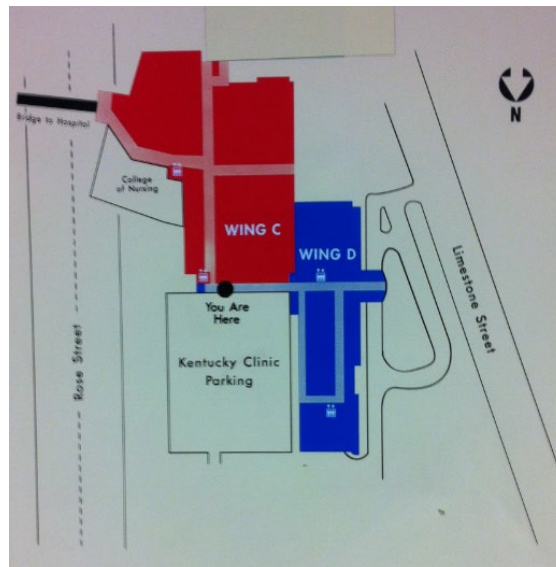

All signs must comply with current ADAAG Guidelines and KY Building Codes.

101400S01 SIGNAGE– Identifying Devices

Room Identification Signs

All spaces within a building are required to have at least one basic signage with the room number, stair number, elevator number, accessible restroom symbols and egress/exit signage adjacent to the latch side of the door / entrance to the space. All room numbers must be raised from the plate in tactile letters and in Braille. Other supplemental text does not need to be raised or in Braille unless noted otherwise below.

See [00030S01 – Room Numbering Standard](#) - Articles 2.0 and 6.0 through 6.13 tables in red text for 'Room Signage' text/number requirements. If the 'Room Signage' columns of the tables in the Room Numbering Standard do not address a specific room signage issue contact the Facilities Information Coordinator (or his/her designated representative).

Basic Room Number Signs

Small room ID signs meeting ADAAG Guidelines are to be used for small storage rooms, closets, coat rooms, pipe chases, and secondary entrances to a main departmental office suite.



As part of the basic interior building room signage provide a signage plaque identifying each: Building Operator Storage, Building Operator, Communication Closet, Custodial Closet, Electrical Closet, Mechanical Room & Elevator Equipment Room.

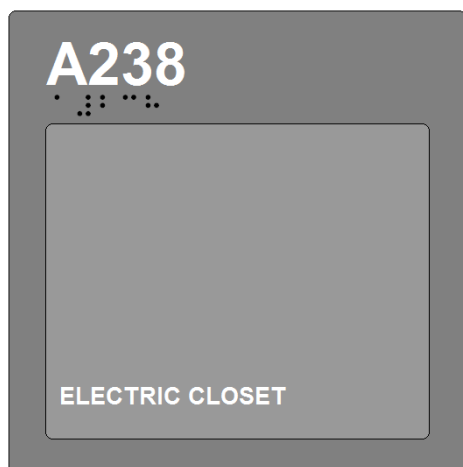

All signs must comply with current ADAAG Guidelines and KY Building Codes.

101400S01 SIGNAGE– Identifying Devices

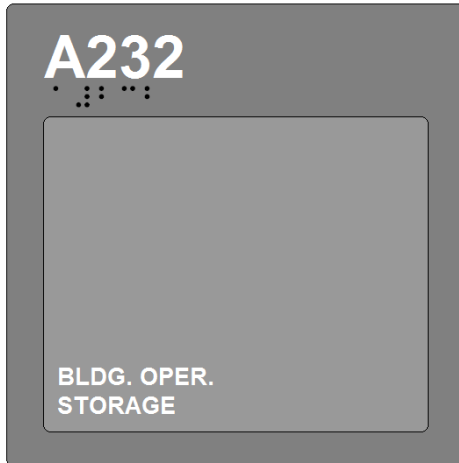

Rooms with permanent ID:

Building Operator
Building Operator Storage
Communication Closet
Custodial Closet
Electrical Closet
Elevator Equipment Room
Kitchen
Lactation Room
Mechanical Room
Staff Only
Storage Room

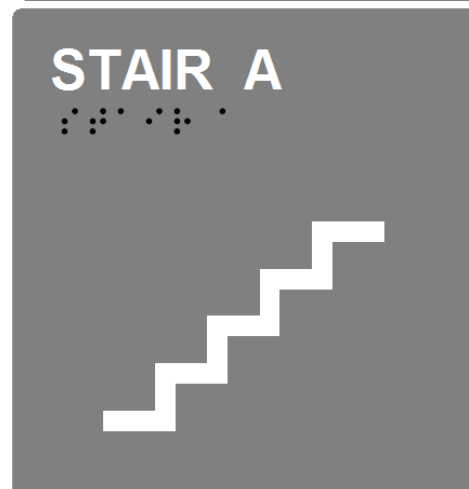

All signs must comply with current ADAAG Guidelines and KY Building Codes.

101400S01 SIGNAGE– Identifying Devices

Restroom Identification Signage

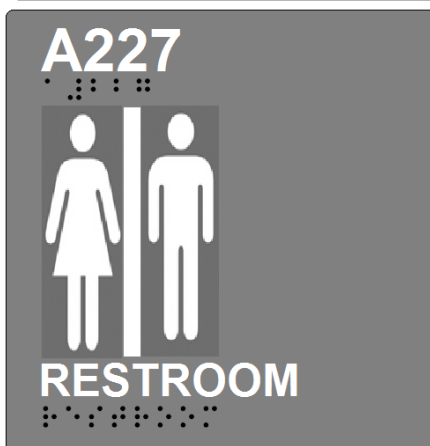
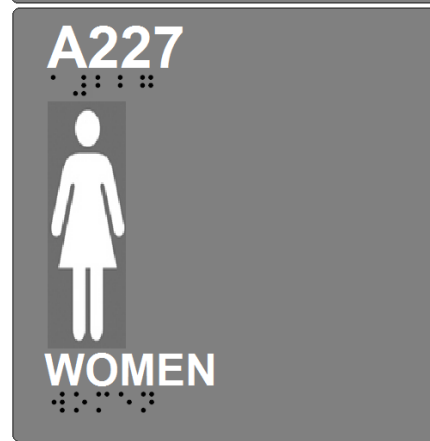
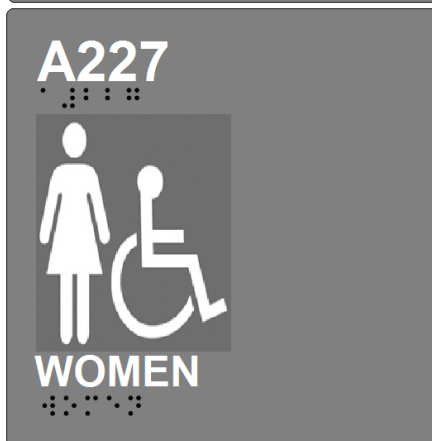
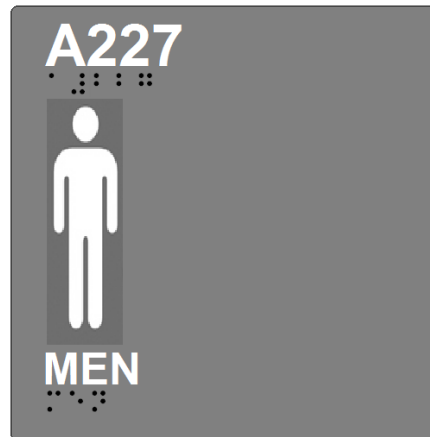
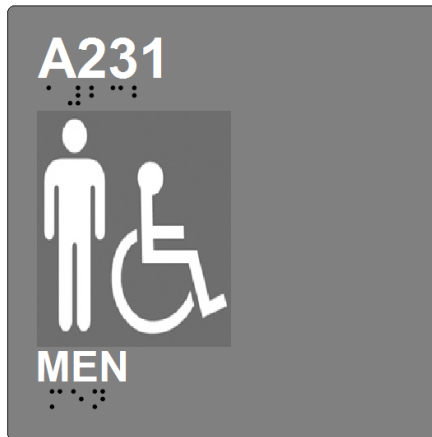

All signs must comply with current ADAAG Guidelines and KY Building Codes.

101400S01 SIGNAGE– Identifying Devices



Use the signs on the left with the wheelchair symbol to indicate restrooms that meet ADA guidelines for accessible restrooms. For all other restrooms, use the signs on the right. The Room Number must be on the sign.

Note: At all non-accessible restrooms, a sign must be added indicating the location of the nearest accessible restroom.

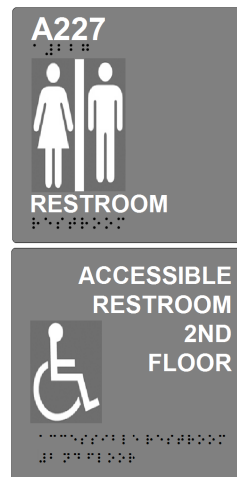
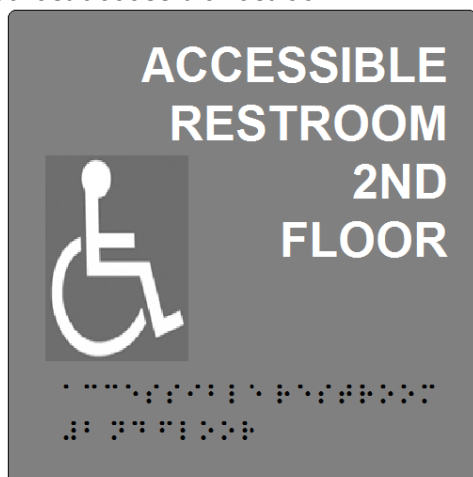

At all non-accessible restrooms, a sign must be added indicating the location of the nearest accessible restroom. All sign edges must be smooth and corners rounded to remove sharpness.

Mount sign directly below the restroom room sign leaving ¼” space between the two signs.

Tape mount to wall using ¾” double adhesive foam tape.

All signs must comply with current ADAAG Guidelines and KY Building Codes.

101400S01 SIGNAGE– Identifying Devices

Offices, Conference Rooms, Departments

Provide a room number with copy window for spaces where the usage / occupants may change over time. Copy window to accept card stock paper normally used for report covers.



All signs must comply with current ADAAG Guidelines and KY Building Codes.

101400S01 SIGNAGE– Identifying Devices

Directional Signs

Basic Directional Signage – Stairs

Provide signs inside each stair indicating the stair number, the floor, range of floors the stairs serve, whether or not the stairs access the roof, and direction for exit discharge.



- All edges to be smooth and corners sanded to remove sharpness.
- Locate signs inside stairwells on the latch side of the door to the hallway.
- Mounting height – same as standard room signs as noted in Section 7 of this standard.
- Tape mount to wall using ¾” double adhesive foam tape.

All signs must comply with current ADAAG Guidelines and KY Building Codes.

101400S01 SIGNAGE– Identifying Devices

Corridor Directional Signs

To facilitate viewing suspend Directional Signs from the ceiling where possible.



Directional Signs mounted to walls become lost in the visual clutter of tack boards, announcements and crowded hallways. (see red circled directional sign on wall) To facilitate viewing suspend Directional Signs from the ceiling where possible. NOTE: Placement has to be coordinated with sprinkler heads / Exit signs and approved by the UK Fire Marshall.

Signs that provide direction to or information about spaces within a facility are generally wall mounted, projected, or suspended overhead (supported to structure not ceiling grid). They are not required to contain tactile characters or Braille, but must meet the requirements for visual characters:

- Characters shall contrast with their background and both shall have a non-glare finish.
- Characters can be uppercase, lowercase, or a combination of both.
- Type style shall be conventional in form. Characters shall not be italic, oblique, script, highly decorative, or of other unusual forms.
- Character width: Compliant fonts must meet the following: The width of the upper case “O” shall be 55% - 110% of the character height of the upper case “I”. The stroke thickness of the upper case “I” shall be 15% maximum of the character height.
- Character line spacing: 135% - 170% of the character height.
- Character stroke thickness of the uppercase letter “I” shall be 10% - 30% of the height of the character.
- Spacing between individual characters, excluding word spaces, shall be 10% - 35% of the character height.

All signs must comply with current ADAAG Guidelines and KY Building Codes.

101400S01 SIGNAGE– Identifying Devices

- Character height is based on height above the floor and minimum viewing distance. Refer to the ADA Chapter 7 Communication, Elements & Features Table 703.5.5 for character height recommendations.

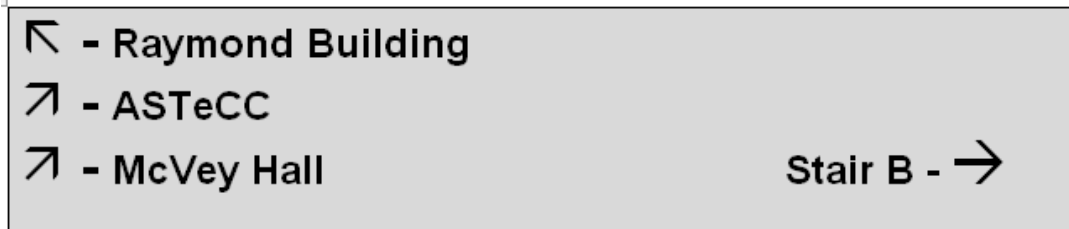

All signs must comply with current ADAAG Guidelines and KY Building Codes.

101400S01 SIGNAGE– Identifying Devices

Laboratory Signs

Basic Laboratory Signage

Two types of room identification signs will be used. The primary room number sign for a particular room and will include raised, 5/8" letters indicating the room number. Braille code will also be included directly below these raised letters. A brief description of the room use, e.g., laboratory, storage room, or other appropriate description can be included. All text on the sign frame is to be Helvetica medium font, upper and lower case. The color of the type shall be white on black (or dark) background.

In addition to the normal Room Number signage provide a Laboratory signage plaque at each wet laboratory sized for a 8 ½ x 11 insert and made of a molded acrylic frame and a polypropylene insert. The sign is to have a 5/32" thick back plate with a 1/16" thick, matte, clear, optically correct acrylic face plate.

Flush mounted plaques are to be adhered to the wall on the latch side .and mounted per Section 7.7 of this document.

Special Requirements for Laboratory Room Identification Signs and Inserts Purpose:

- 1.) The primary purpose of the University of Kentucky Laboratory Sign Insert is to provide uniform and accurate emergency information to first-responders (e.g., fire department, hazardous materials, and UK police personnel). A secondary purpose for laboratory signage is to identify the person responsible for the lab and names of contact people for Environmental Health and Safety Division personnel, Physical Plant Division personnel, and others in need of this information.
- 2.) The Laboratory Signage Guideline requires a certain minimum set of information for all UK Laboratory Signage while allowing flexibility to accommodate special needs.
- 3.) Standardization of laboratory sign information and format will reduce potential health and safety hazards for emergency personnel, improve care for injured, and should speed contact with relevant laboratory personnel in the event of any emergency situation in the laboratory (including non-health & safety related situations).
- 4.) The standardized laboratory sign will allow convenient and uncomplicated updating of information.
- 5.) The laboratory sign will perform the basic tasks of informing visitors/emergency responders of:
 - Special hazards in a laboratory
 - Identifying "emergency contact" personnel, and
 - Meeting regulatory requirements (chemical, biological and radiation hazards)

All signs must comply with current ADAAG Guidelines and KY Building Codes.

101400S01 SIGNAGE– Identifying Devices

Scope

- 1.) Laboratories that contain chemical, biological or radiation hazards or are otherwise required to have a Chemical Hygiene Plan will be required to comply with these signage guidelines.
- 2.) Storage rooms used for chemicals or radioactive materials (including waste storage) will also be required to comply with these signage guidelines.
- 3.) Laboratories and other facilities which do not handle chemicals as defined in the UK Chemical Hygiene Plan but which pose a significant potential safety or health hazard to emergency personnel will be considered to be within the scope of these guidelines. Examples of such labs include:
 - High voltage laboratories (over 440 volts)
 - Laser laboratories

Sign Insert content can be found on Environmental Health & Safety’s web site here (http://ehs.uky.edu/docs/pdf/bio_s_lab_signage_0001.pdf) and is to be filled in by the occupants of the lab:

ADMITTANCE TO AUTHORIZED PERSONNEL ONLY

CAUTION: The following hazards are present within this area:

Flammables
 Self Reactives
 Pyrophorics
 Self-Heating
 Emits Flammable Gas
 Organic Peroxides

Oxidizers

Explosives
 Self Reactives
 Organic Peroxides

Corrosives

Carcinogen
 Respiratory Sensitizer
 Reproductive Toxicity
 Target Organ Toxicity
 Mutagenicity
 Aspiration Toxicity

Irritant
 Dermal Sensitizer
 Acute toxicity (harmful)
 Narcotic Effects
 Respiratory Tract
 Irritation

Acute Toxicity (severe)

Gas Under Pressure

Biohazards
 IBC #

(Biohazard symbol here)

Human pathogens
 Viral vectors
 BSL N/A

Strong Magnetic Field

Laser (class)

Radioactive Material

Special procedures required for entry or exit:

Room Number:

Department:

Principal Investigator: Supervisor:

Emergency and After Hours Contacts for this Laboratory:

| Name | Office Location | Office Phone | Cell or Home Phone |
|------|-----------------|--------------|--------------------|
| | | | |
| | | | |

University of Kentucky
ENVIRONMENTAL HEALTH AND SAFETY

Biological Safety 237-1049
 Environmental Management 323-6280
 Occupational Health 257-3242
 Radiation Safety 323-6777

IN CASE OF EMERGENCY CALL 911

The information on this sign must be updated at least annually or in the event of any change of emergency contacts or special hazards.

Prepared by: Date Posted:

All signs must comply with current ADAAG Guidelines and KY Building Codes.

101400S01 SIGNAGE– Identifying Devices

Lab Bench Signage

Confirm with the Project Manager for requirement, but normally in large Open Plan Labs the benches are numbered (see 6.07 of Room Numbering Standard) as each bench is assigned to a specific researcher / grant. Provide bench signage similar to the sample sign(s) below suspended from the ceiling at each bench. Where lab benches are back to back the lab bench signage for the next row would be mounted to the back side of the first lab bench sign if separate signage material is utilized. The next set of benches in the open lab plan would be LB201-03 and LB201-04. 'LB' stands for Lab Bench, '201' is the room number and '-01' is the bench number. Note Laboratory Benches are the only location where the use of hyphens is pre-approved.



Character height is based on height above the floor and minimum viewing distance. Refer to the [ADA Chapter 7 Communication, Elements & Features Table 703.5.5](#) for character height recommendations.

All signs must comply with current ADAAG Guidelines and KY Building Codes.

101400S01 SIGNAGE– Identifying Devices

Regulatory Signage

Exit Signs

EXIT signs are used for doors that allow you to re-enter from the outside, excluding main entry doors to a building.

EXIT ONLY signs are commonly used for doors that remain locked from the outside.

EMERGENCY EXIT ONLY signs are commonly used for doors that remain locked from the outside and are to be used in the event of an emergency.

ALARM signs are commonly used inside Libraries, Labs and other secure facilities with controlled access/egress.



Emergency Evacuation Signs

The preparation of emergency exit plans, procedures, and evacuation signs shall be coordinated by the Project Manager and approved by the University Fire Marshall during design of major renovations and new construction.

Emergency Evacuation Signs – Signs posted inside University buildings that indicate the evacuation routes, map legend, location of manual pull stations, fire extinguishers, elevators, and stairs, information on how to exit the building, and the emergency phone number.

Emergency Exit Route - The pathway of a means of egress that is separated from all other spaces of the building to provide a protected way of travel to the exit.

All signs must comply with current ADAAG Guidelines and KY Building Codes.

101400S01 SIGNAGE– Identifying Devices

Emergency Evacuation Signs shall have a frame size of 12 ½” x 15 ½”, glare free acrylic frame, reverse painted border, radius corners, with VHB tape on the back. The frame shall allow for a 11” x 14” matt insert containing the approved emergency evacuation sign. All emergency evacuation signs must be submitted to the University Fire Marshall for inspection and approval prior to their implementation. Items to be reviewed will be:

- Title of sign (e.g. “Evacuation Routes”)
- Name of building
- Name/number of floor
- Location of “You are Here” symbol
- Exit routes
- Statement that reads “For Any Emergency - Dial 911”
- Map legend

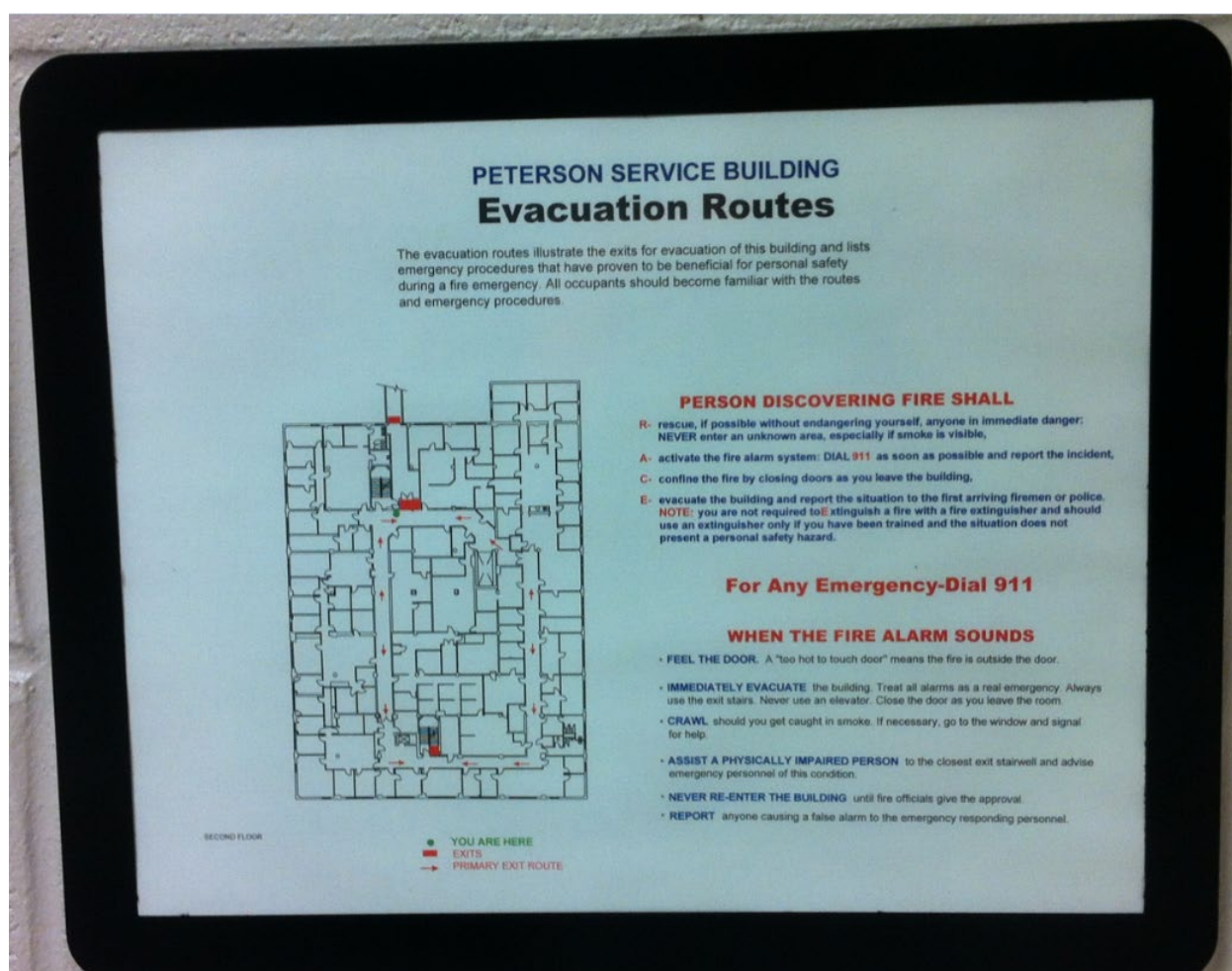

All signs must comply with current ADAAG Guidelines and KY Building Codes.

101400S01 SIGNAGE– Identifying Devices

Room Occupancy Capacity Signs

Occupant Capacity Sign: Maximum Occupant Capacity signs, pursuant to Kentucky Building Code requirements shall be posted interior to the posted room and shall be adjacent to the latch side of all University classrooms, conference rooms, and other rooms of assembly with a capacity of 50 or more people and approved by the University Fire Marshall before posting.

Occupant Capacity Signs shall have a frame size sized for an 8 ½” x 11” insert, glare free acrylic frame, reverse painted border, radius corners, with VHB tape on the back containing the approved maximum occupancy capacity sign as provided by the University Fire Marshall.

| |
|---|
| <p>University of Kentucky</p> <p><i>Environmental Health and Safety</i></p> <p><i>Fire Marshal's Office</i></p> <p><u>OCCUPANCY CAPACITY</u></p> <p>Building Name: _____</p> <p>Building Number: _____</p> <p>Room Number: _____</p> <p>Maximum Occupant Load: _____</p> <p>(Maximum Occupant load is based upon the combination of tables and chairs and fixed seats.)</p> <p>_____ → → Date: _____</p> <p>Greg Williamson → → → → _____</p> <p>UK Fire Marshal</p> |
|---|

All signs must comply with current ADAAG Guidelines and KY Building Codes.

101400S01 SIGNAGE– Identifying Devices

Room Identifying Signage Mounting Installation/Heights

Room Sign Installation for 'Single Door with Sign'

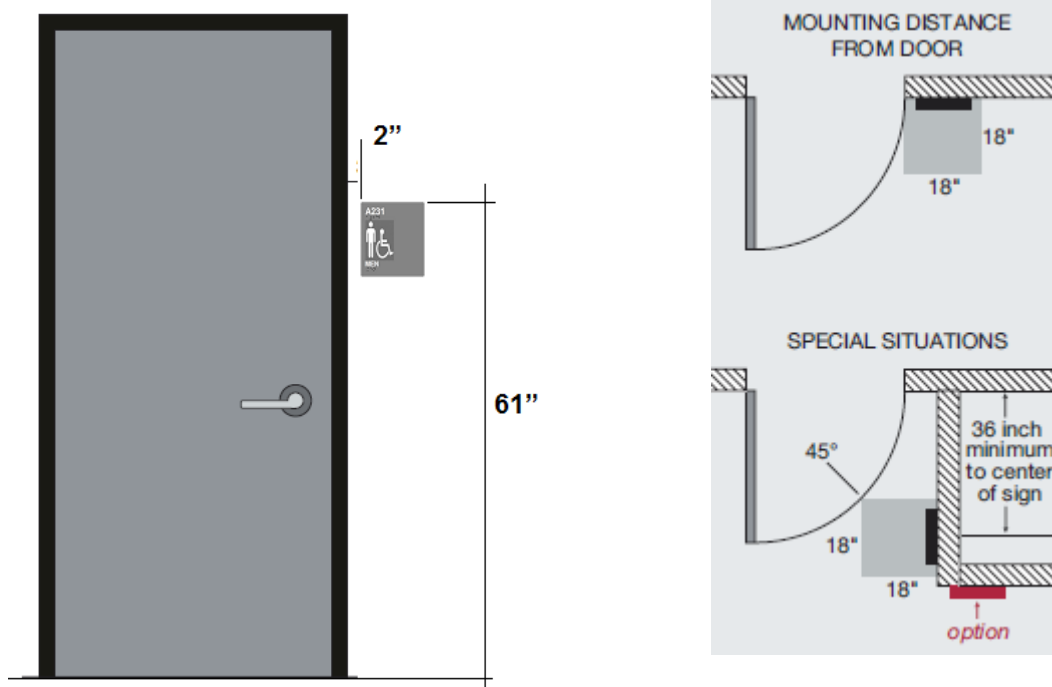

The most common mounting application is for single doors. The building code requires that all tactile characters shall be 48 inches minimum and 60 inches maximum above the floor, measured from the baseline of the characters. The code also requires distance between the edge of the door and the sign – a minimum 18 x 18 inches space on the floor, centered on the sign, beyond the arc of any door swing between the closed position and 45° open position (see drawing in sidebar).

To maintain a consistent mounting height the following criteria are to be used for mounting room signs:

- Mount the sign on the latch side of door. If no wall space exists on the latch side of the door, mount the sign on the nearest adjacent wall.
- Distance from door frame to sign = 2 inches minimum.
- Distance from floor to top of sign = 61 inches.
- Tape mount to wall using 3/4" foam adhesive tape.

NO SIGNS MAY BE INSTALLED ON DOORS unless there is no other option available.

All signs must comply with current ADAAG Guidelines and KY Building Codes.

101400S01 SIGNAGE– Identifying Devices

Sign Installation Option for Exit Doors

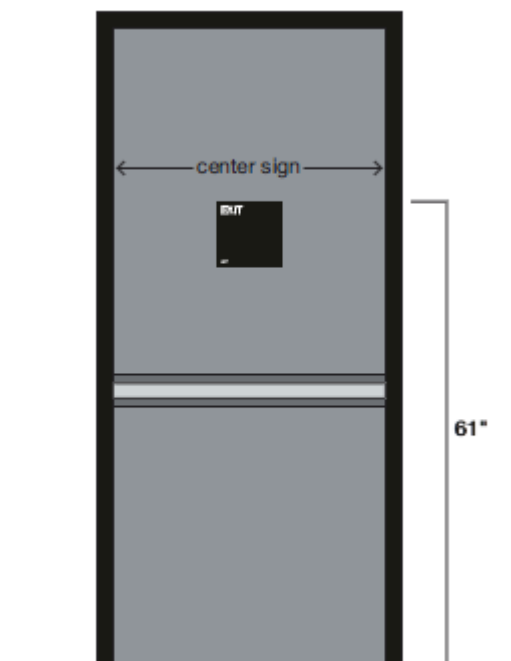

Usage:

Doors that open away from the user and have automatic door closures without hold-open devices, such as most Exit doors.

Signs can be mounted on the push side of doors that open away from the user and have automatic door closures without hold-open devices. This type of situation usually applies to Exit doors, but can apply to room doors as well. Whenever possible, the standard wall mounting position should be used as shown for a 'Single Door with Sign' before this option is considered.

- Center the sign (horizontally) on the door.
- Distance from floor to top of sign = 61 inches.
- Tape mount to wall using 3/4" foam adhesive tape.

All signs must comply with current ADAAG Guidelines and KY Building Codes.

101400S01 SIGNAGE– Identifying Devices

Room Sign Installation for Doors with Small Sidelights

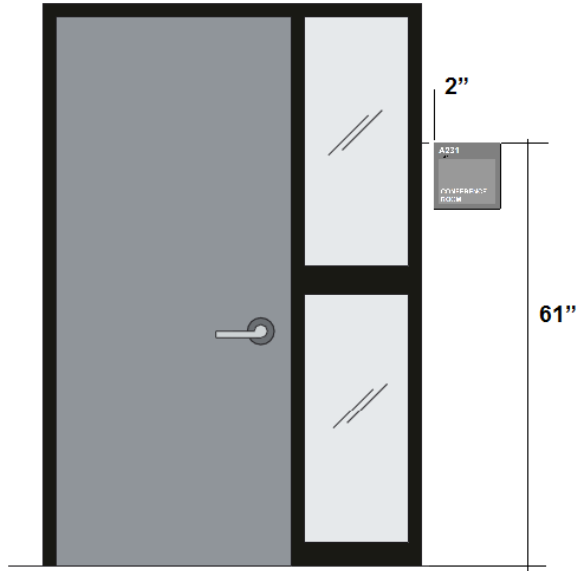

USAGE:

Rooms whose entry doors have small glass sidelights adjacent to the latch side of the door that are less than 18 inches wide.

For room entry doors that contain glass sidelights which are smaller than 18 inches in width, mount the sign next to the sidelight on the wall.

- Mount the sign on the latch side of door. If no wall space exists on the latch side of the door, mount the sign on the nearest adjacent wall.
- Distance from sidelight frame to sign = 2 inches.
- Distance from floor to top of sign = 61 inches.
- Tape mount to wall using 3/4" foam adhesive tape.

All signs must comply with current ADAAG Guidelines and KY Building Codes.

101400S01 SIGNAGE– Identifying Devices

Room Sign Installation for Doors with Large Sidelights

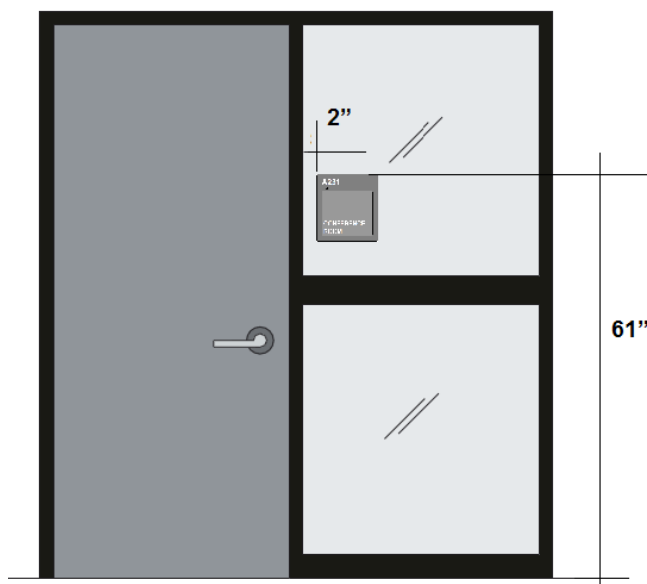

Usage:

Rooms whose entry doors have small glass sidelights adjacent to the latch side of the door that are greater than 18 inches width.

For room entry doors that contain glass sidelights which are greater than 18 inches in width, mount the sign directly onto the glass sidelight as shown above.

- Mount the sign on the latch side of door.
- Distance from sidelight frame to sign = 2 inches.
- Distance from floor to top of sign = 61 inches.
- Apply black vinyl backer to the glass sidelight (slightly smaller than the size of the sign) with 1/2" clear adhesive tape and then tape the sign to the vinyl backer using 3/4" foam adhesive tape.

All signs must comply with current ADAAG Guidelines and KY Building Codes.

101400S01 SIGNAGE– Identifying Devices

Room Sign Installaton for Double Doors with Normally Inactive Leaf

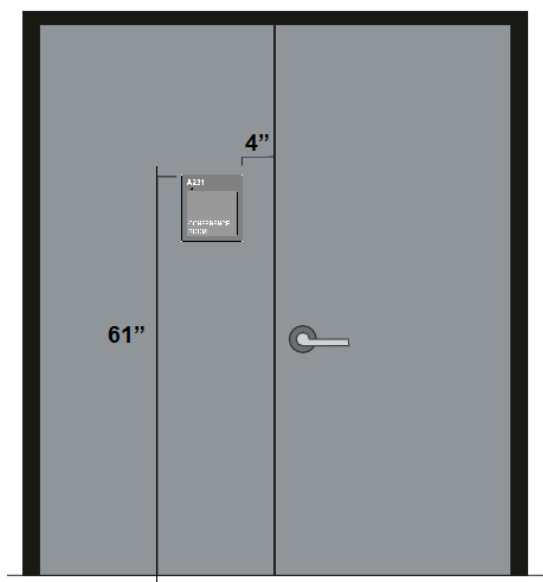

Usage:

Rooms with double entry doors where one door is used as the primary entry and the other door is locked and only used on occasion.

Doors to a mechanical room is a common example.

For rooms with double entry doors where one door is the primary entry door and the other door is in the locked position (this door usually does not contain a door handle), the sign should be mounted on the inactive leaf as shown above.

- Mount the sign on the latch side of door. If no wall space exists on the latch side of the door, mount the sign on the nearest adjacent wall.
- Distance from edge of door to sign = 4 inches.
- Distance from floor to top of sign = 61 inches.
- Tape mount to wall using 3/4" foam adhesive tape.

All signs must comply with current ADAAG Guidelines and KY Building Codes.

101400S01 SIGNAGE– Identifying Devices

Room Sign Installation for Double Doors with Both Doors Active

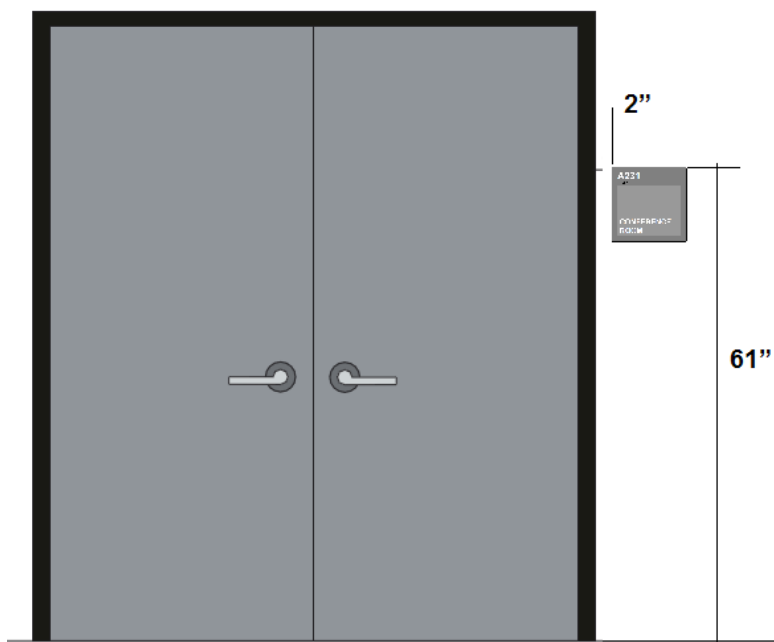

Usage:

Rooms with double entry doors where both doors are in use.

Doors to theaters and auditoriums are common examples.

For rooms with double entry doors where both doors are available to enter the room, mount the sign adjacent to the right hand door as shown above.

- Mount the sign on the latch side of door. If no wall space exists on the latch side of the door, mount the sign on the nearest adjacent wall.
- Distance from door frame to sign = 2 inches.
- Distance from floor to top of sign = 61 inches.
- Tape mount to wall using 3/4" foam adhesive tape.

All signs must comply with current ADAAG Guidelines and KY Building Codes.

101400S01 SIGNAGE– Identifying Devices

Room Sign Installation for Laboratory Doors

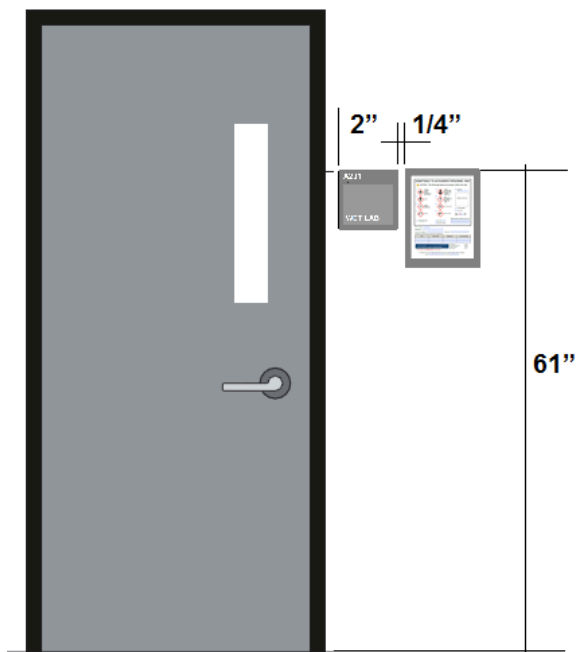

- Mount the room sign on the **latch side of door**. If no wall space exists on the latch side of the door, mount the sign on the nearest adjacent wall.
- Distance from door frame to sign = 2 inches minimum.
- Distance from floor to top of sign = 61 inches.
- Tape mount to wall using 3/4" foam adhesive tape.
- UK Environmental Health & Safety is to be contacted for any unusual mounting issues.

NO SIGNS MAY BE INSTALLED ON DOORS unless there is no other option available.

All signs must comply with current ADAAG Guidelines and KY Building Codes.