



Signage Fabrication/Design Intent Drawings

Pavilion A

June 21, 2017





A PRIMARY LOGO - HORIZONTAL
G.1.02



B PRIMARY LOGO - VERTICAL
G.1.02

ABCDEFGHIJKLMNOPQRSTUVWXYZ
abcdefghijklmnopqrstuvwxyz
1234567890

Univers 57 Condensed

C PROJECT FONTS
G.1.02

ABCDEFGHIJKLM
NOPQRSTUVWXYZ
abcdefghijklmno
pqrstuvwxyz
1234567890

Univers 67 Bold Condensed

Drawing Title:
**PROJECT STANDARDS -
PROJECT LOGOS**
WAYFINDING
BP-6.01
G.1.02



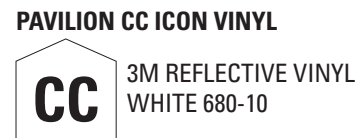
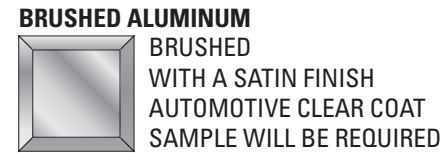
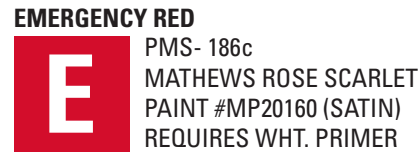
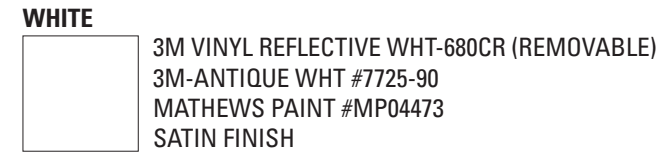
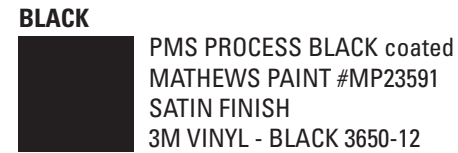
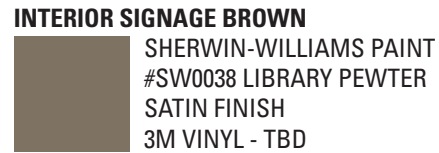
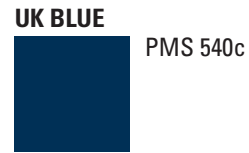

NOTE THESE BLOCKS ARE A COMPUTER REPRESENTATION OF THE COLORS. AS SUCH THEY ARE ONLY A CLOSE APPROXIMATION OF THE ACTUAL COLORS. PLEASE REFER TO THE ACTUAL PANTONE SWATCHES FOR A MORE ACCURATE COLOR MATCH.

NOTE ALTERNATIVES TO THE 3M VINYL SYSTEM WILL REQUIRE THAT THE FABRICATOR SUBMIT 6" SQUARE SAMPLES FOR APPROVAL. ALSO NOTE THAT ANY SUCH MATERIALS MUST HAVE A COMPARABLE WARRANTY.

NOTE THAT PER THE GENERAL SPECIFICATIONS THE SIGN FABRICATOR IS TO "SUBMIT FOUR (4) 6"X6" SAMPLES OF ALL ACTUAL MATERIAL, PAINT, OR VINYL ON THE SPECIFIC SUBSTRAIGHT TO BE USED FOR EACH DIFFERENT FINISH SURFACE."

NOTE THAT ALL PAINTED ELEMENTS ARE TO HAVE A CLEAR, SATIN FINISH, AUTOMOTIVE GRADE, PROTECTIVE CLEAR COATING

A PROJECT COLOR PALETTE
G.1.03

- ← NOTED AS "LEFT" IN THE MESSAGE SCHEDULE
- ↖ NOTED AS "UP/L" UP LEFT IN THE MESSAGE SCHEDULE
- ↑ NOTED AS "UP" IN THE MESSAGE SCHEDULE
- ↗ NOTED AS "UP/R" UP RIGHT IN THE MESSAGE SCHEDULE
- NOTED AS "RIGHT" IN THE MESSAGE SCHEDULE
- ↓ NOTED AS "DOWN" IN THE MESSAGE SCHEDULE

B ARROW DESCRIPTIONS
G.1.03

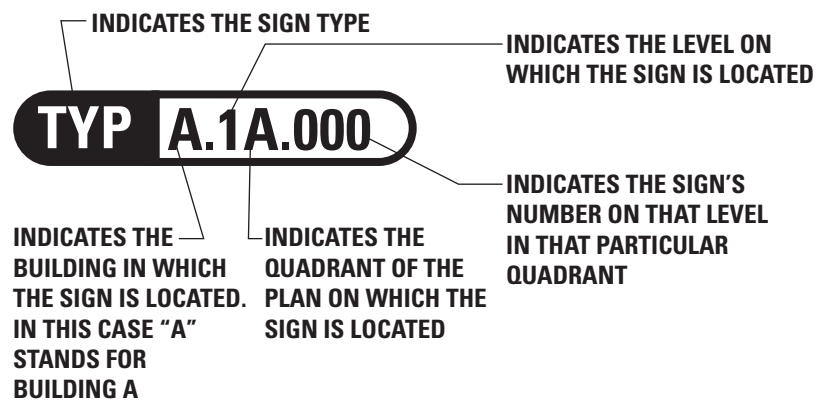

C TYPICAL LOCATION PLAN LABEL
G.1.03

Drawing Title:
**PROJECT STANDARDS -
FONTS, COLORS, GENERAL**
WAYFINDING
BP-6.01
G.1.03

UK HealthCare Pavilion A – Typical Elevator Lobby Level Artwork Panel (LEV)

Interior Signage | Design Intent Drawings – scale: 1/2" = 1'-0"

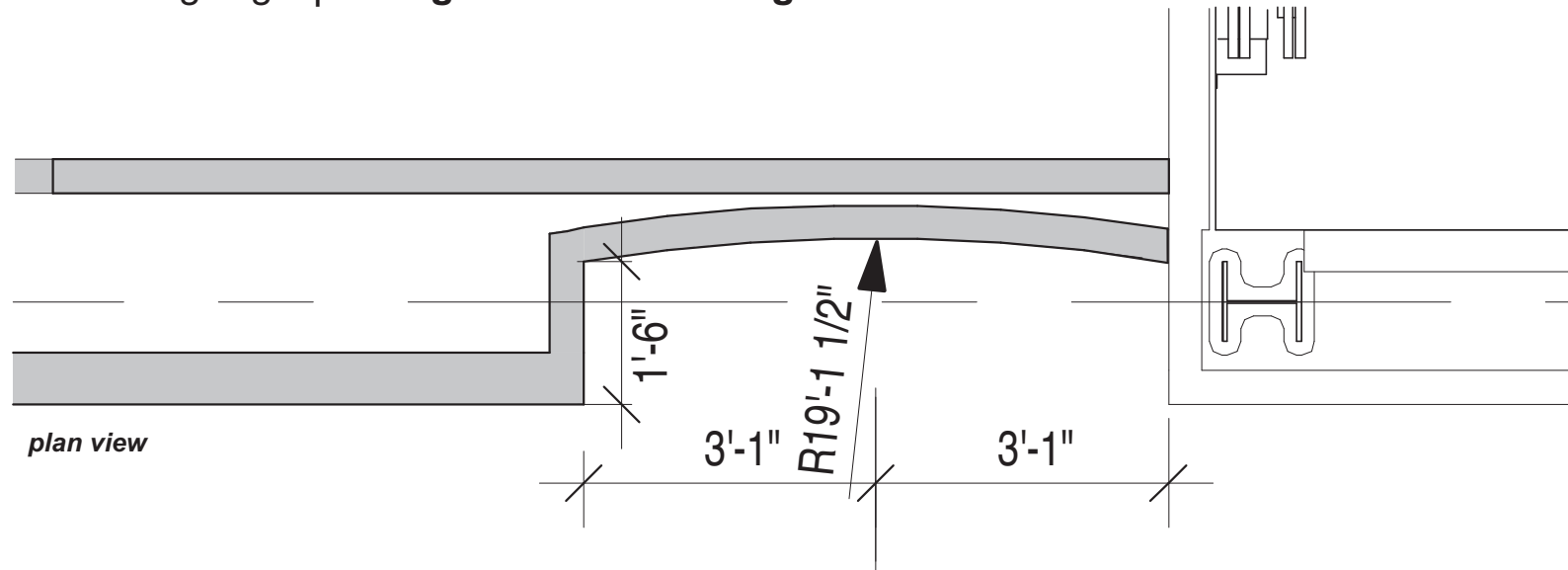

Typical Elevator Lobby Level Artwork Panel (LEV)

6'-2"w x 7'-2"h printed canvas or wallpaper graphic applied to recessed wall.

Image/Art files will be provided UK HealthCare

NOTE: Lighting and cove details are by others

NOTE: Fabricator is to field verify all dimensions prior to fabrication

NOTE: Fabricator is to provide minimum of three 8 1/2" x 11" printed, finished material samples for approval prior to fabrication

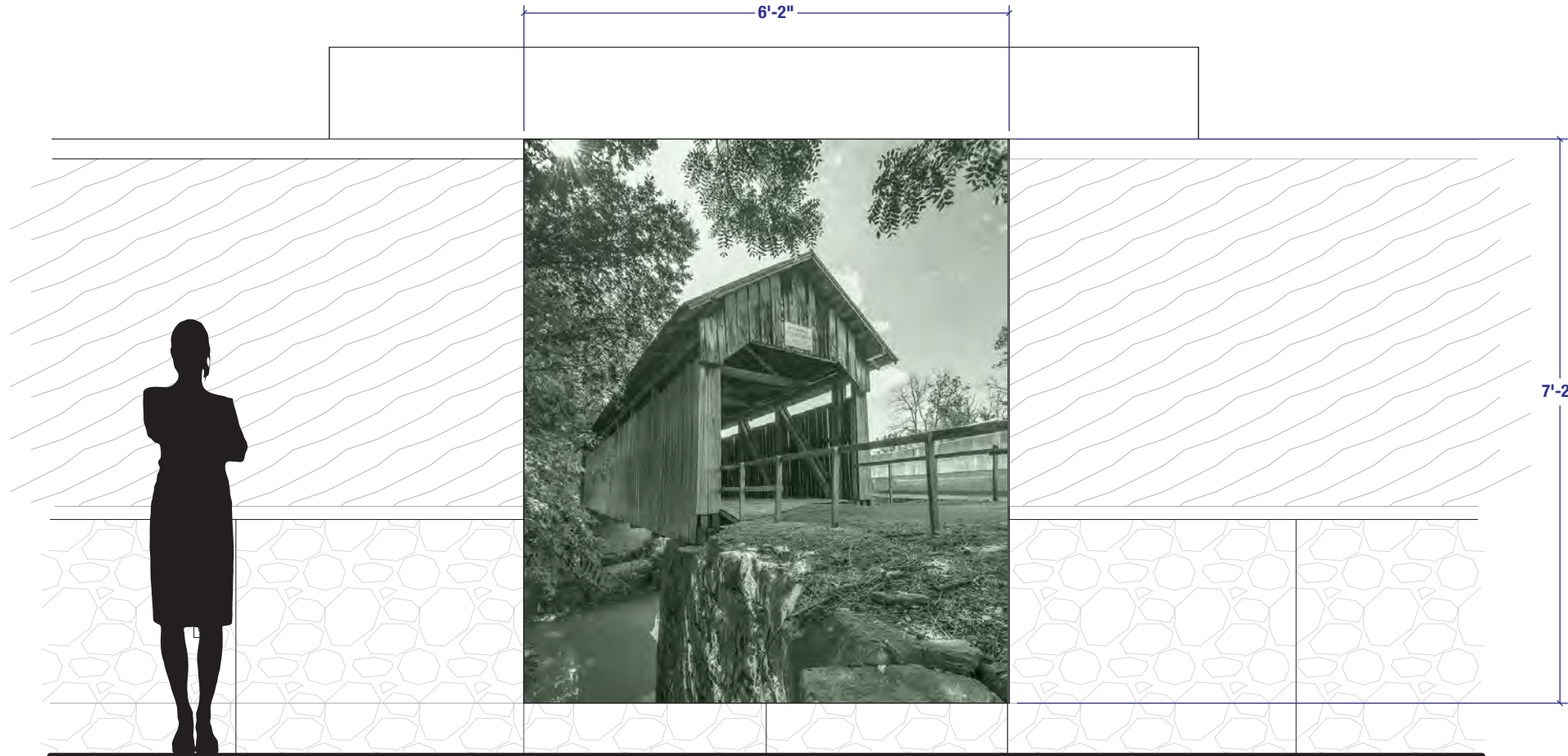

Existing Campus Example

1 TYPICAL ELEVATOR LOBBY LEVEL ARTWORK PANEL (LEV)
A832 SCALE: 1/2" = 1'-0"

Drawing Title:
TYPICAL ELEVATOR LOBBY LEVEL ARTWORK PANEL (PUBLIC LEVEL)

WAYFINDING

Sign Type
LEV

UK HealthCare Pavilion A – Typical Elevator Lobby Directional Plaque (PLQ)

Interior Signage | Design Intent Drawings – scale: 1/2" = 1'-0"

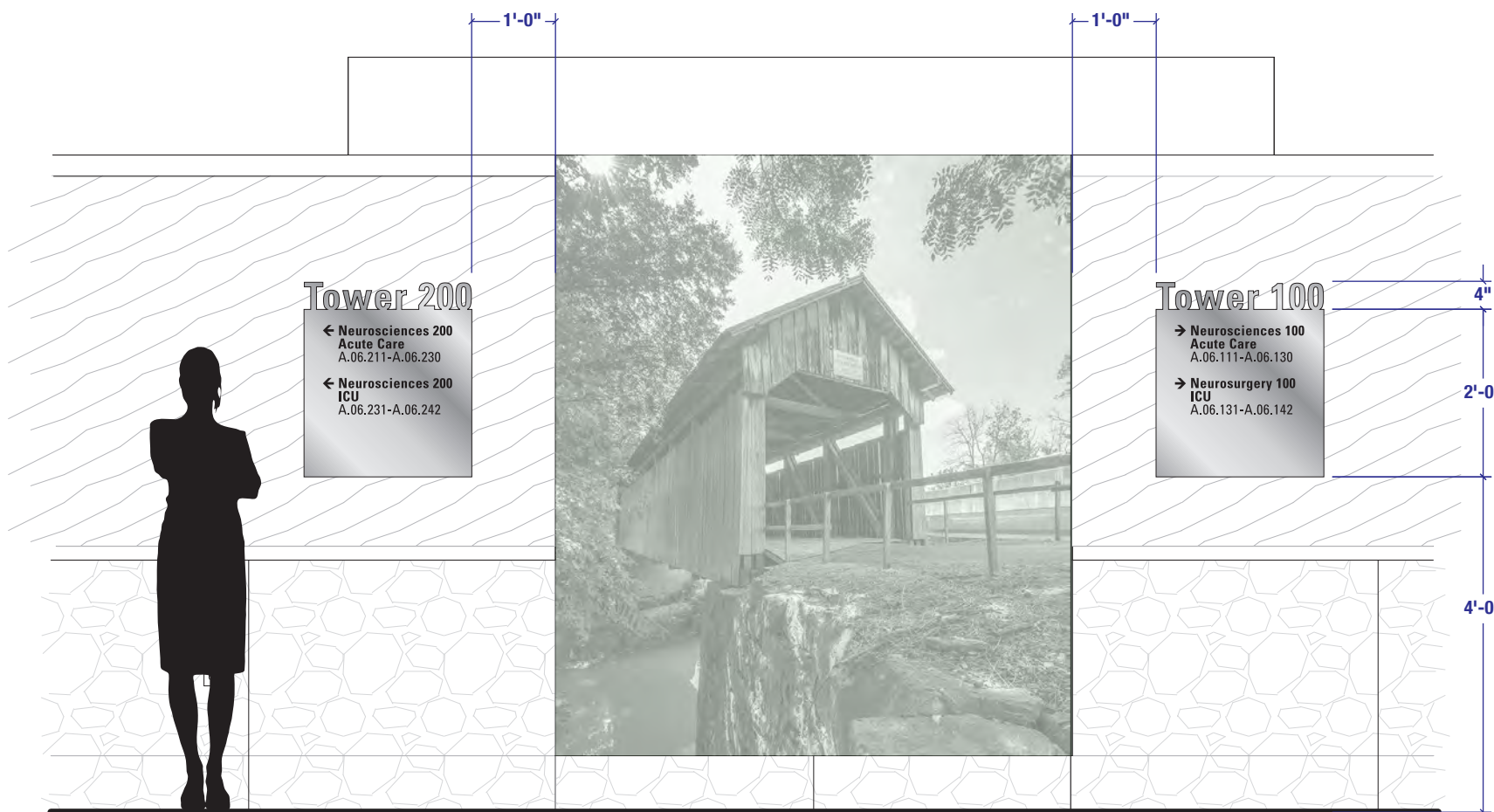
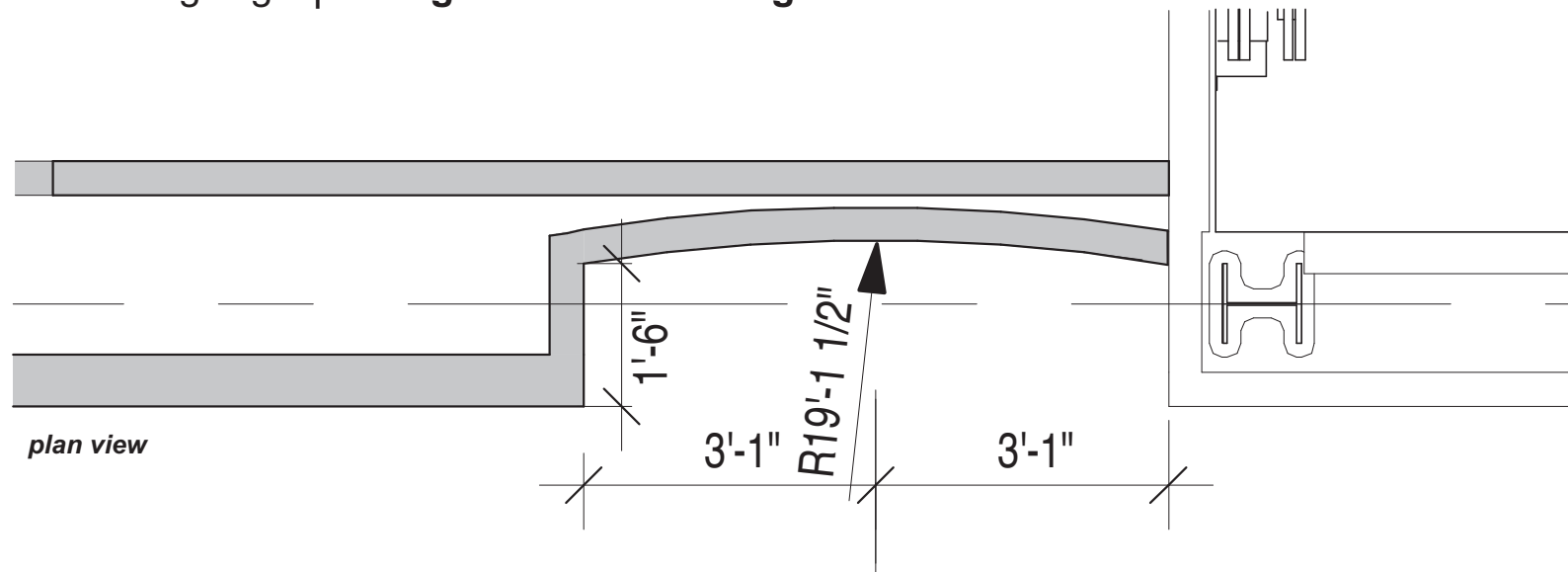

Typical Elevator Lobby Directional Plaque (PLQ)

2'-0" w x 2'-4" h Brushed aluminum panels with chamfered edges

1/4" Brushed aluminum (horizontal grain)

NOTE: Lighting and cove details are by others

NOTE: Fabricator is to field verify all dimensions prior to fabrication

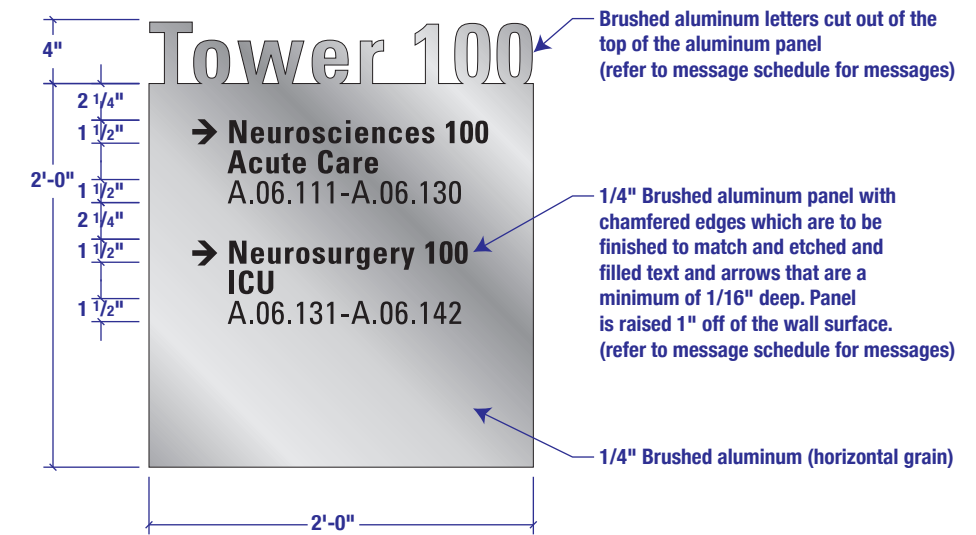

Existing Campus Example

Drawing Title:
TYPICAL ELEVATOR LOBBY
DIRECTIONAL PLAQUE
(PUBLIC LEVEL)

WAYFINDING

Sign Type
PLQ

1 TYPICAL ELEVATOR LOBBY DIRECTIONAL PLAQUE (PLQ)
A832 SCALE: 1/2" = 1'-0"

UK HealthCare Pavilion A – Public Large Wall Mounted Directory (DRL)

Interior Signage | Design Intent Drawings – scale: 1"= 1'-0"

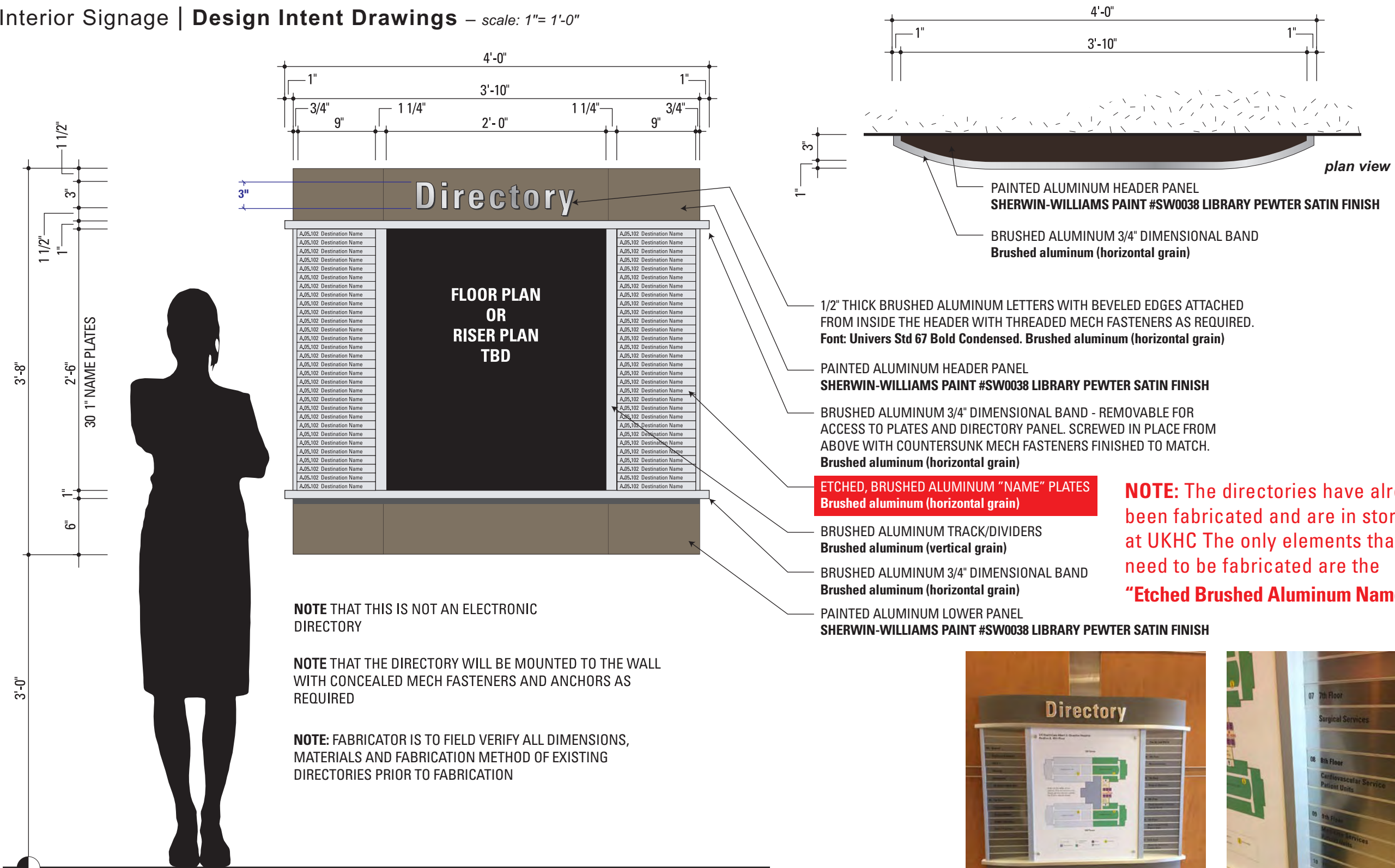

NOTE: The directories have already been fabricated and are in storage at UKHC The only elements that need to be fabricated are the "Etched Brushed Aluminum Name Plates"



Existing Campus Example

3 PUBLIC LARGE WALL MOUNTED DIRECTORY (DRL)
A832 SCALE: 1" = 1'-0"

Drawing Title:
LARGE WALL MOUNTED DIRECTORY (PUBLIC LEVEL)
WAYFINDING
Sign Type
DRL

UK HealthCare Pavilion A – Pin-Mounted Letters (LTR)

Interior Signage | Design Intent Drawings – scale: 2"= 1'-0"

3" Directory

4" Clerk

10" Tower 100

Pin-Mounted Letters (LTR)

1/2" thick brushed aluminum letters with beveled edges
Font: **Univers Std 67 Bold Condensed**
Brushed aluminum (horizontal grain)

Mounted with threaded pins and double-sided silicon tape

NOTE: Sizes will vary based on application and message

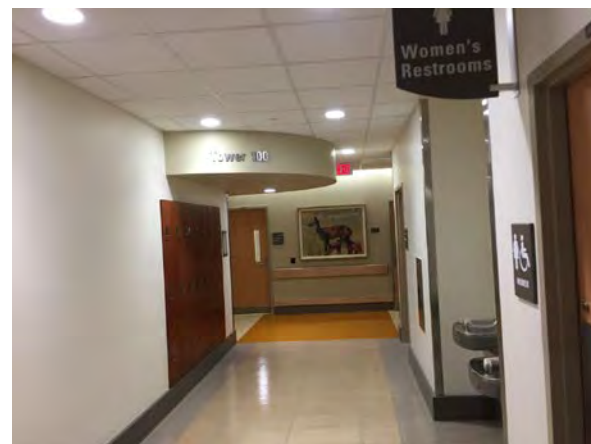

Existing Campus Example

Drawing Title:
**PIN-MOUNTED LETTERS
(PUBLIC LEVEL)**

WAYFINDING

Sign Type

LTR

UK HealthCare Pavilion A – Public Pedestrian Overhead Directional (ODS)

Interior Signage | Design Intent Drawings – scale: 2"= 1'-0"

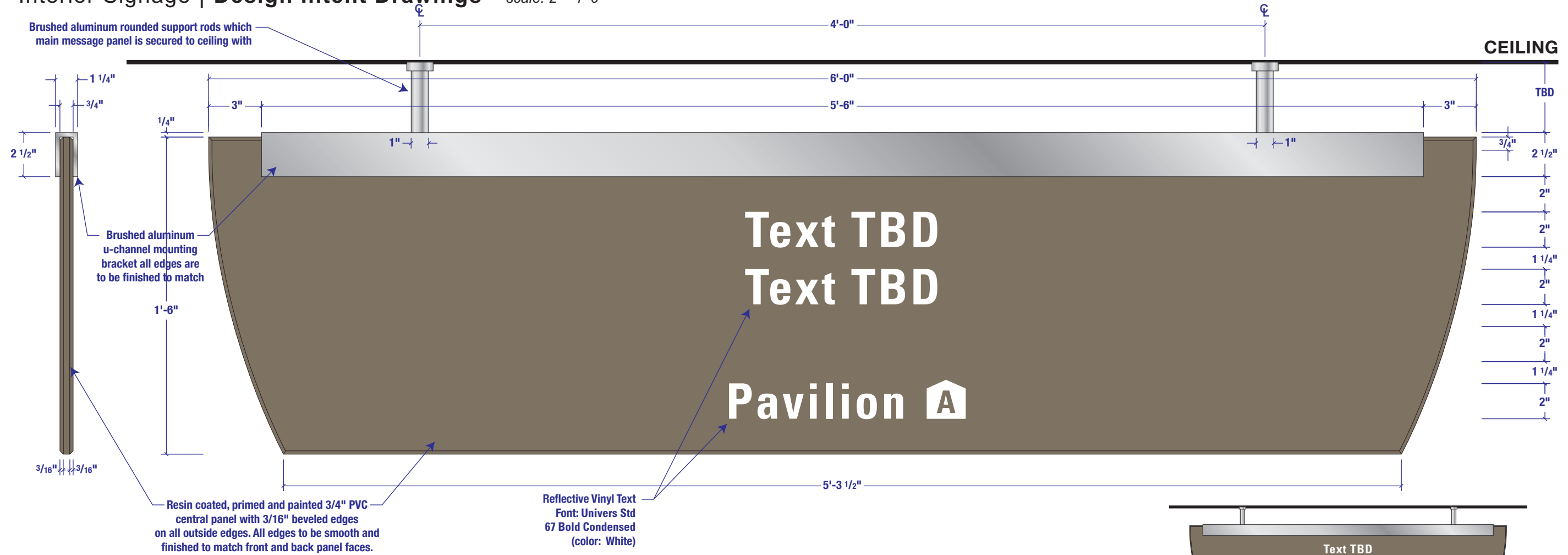

Public Pedestrian Overhead Directional (ODS)

NOTE: This can be a One or Two Sided Sign. Text is always centered.

6'-0"w x 1'-6"h plaque with .1875 beveled edged face panel

Overall sign is painted **SHERWIN-WILLIAMS PAINT #SW0038 LIBRARY PEWTER SATIN FINISH**

5'-6"w x 2 1/2"h x 1 1/4"d brushed aluminum u-channel mounting bracket (horizontal grain)

1"dia x TBD"h brushed aluminum rounded support rods

Reflective vinyl text
Font: **Univers Std 67 Bold Condensed**
(color: White)

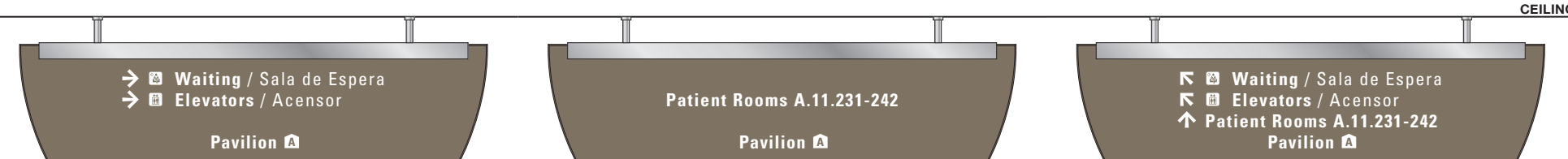
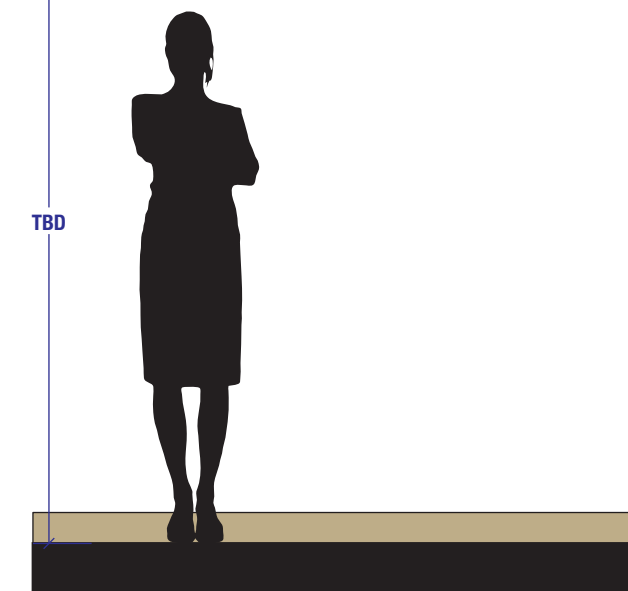
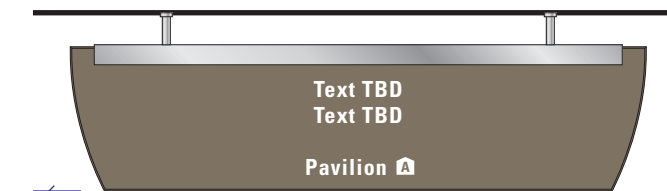

Existing Campus Example

scale 1/2" = 1'-0"

Drawing Title:
PEDESTRIAN OVERHEAD DIRECTIONAL (PUBLIC LEVEL)

WAYFINDING

Sign Type
ODS

UK HealthCare Pavilion A – Public Pedestrian Overhead Directional (ODS)

Interior Signage | Design Intent Drawings – scale: 2"= 1'-0"

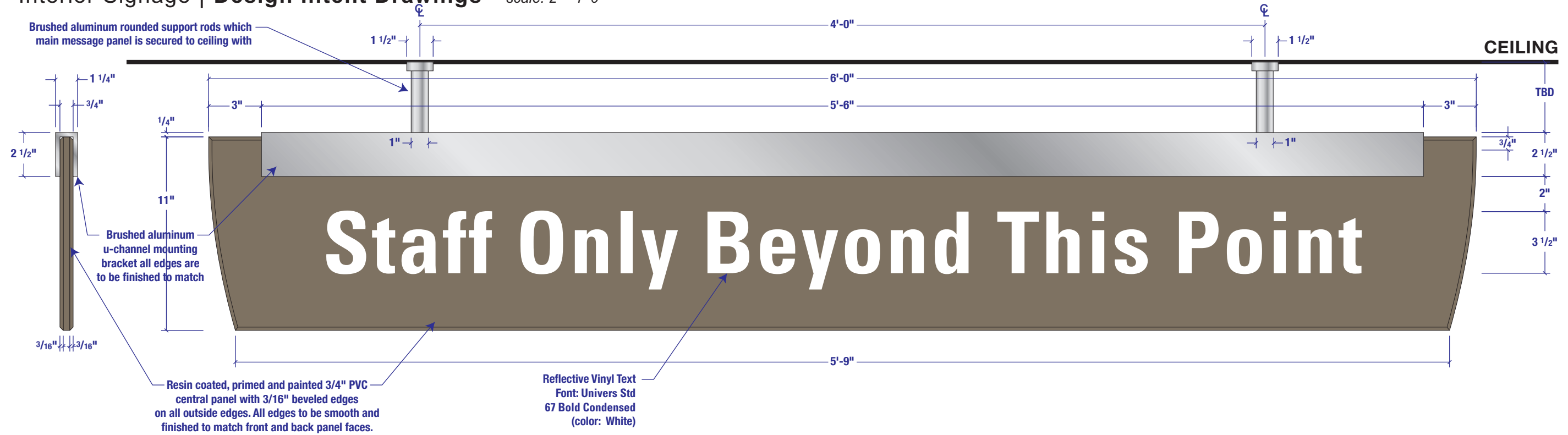

Public Pedestrian Overhead Directional (ODS)

NOTE: This can be a One or Two Sided Sign. Text is always centered.

6'-0" w x 11" h plaque with .1875 beveled edged face panel

Overall sign is painted **SHERWIN-WILLIAMS PAINT #SW0038 LIBRARY PEWTER SATIN FINISH**

5'-6" w x 2 1/2" h x 1 1/4" d brushed aluminum u-channel mounting bracket (horizontal grain)

1" dia x TBD" h brushed aluminum rounded support rods

Reflective vinyl text
Font: **Univers Std 67 Bold Condensed**
(color: White)



Existing Campus Example

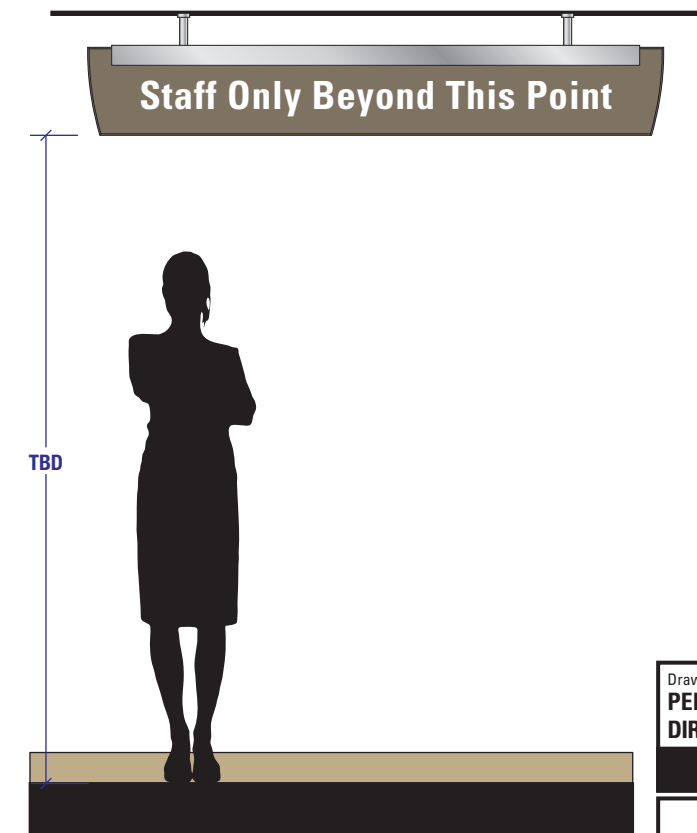

| |
|---|
| Drawing Title: PEDESTRIAN OVERHEAD DIRECTIONAL (PUBLIC LEVEL) |
| WAYFINDING |
| Sign Type ODS |

UK HealthCare Pavilion A – Back of House Overhead Directional (SOD)

Interior Signage | Design Intent Drawings – scale: 2"= 1'-0"

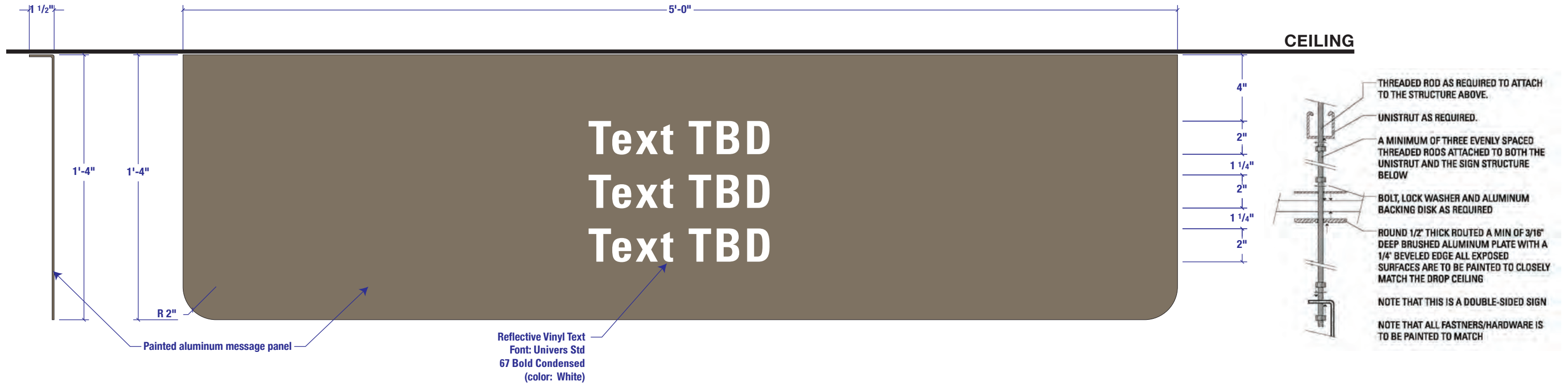

Back of House Overhead Directional (SOD)

NOTE: This can be a One or Two Sided Sign. Text is always centered.

5'-0"w x 1'-4"h x 1/8"t painted aluminum message panel

Overall sign is painted **SHERWIN-WILLIAMS PAINT #SW0038 LIBRARY PEWTER SATIN FINISH**

Reflective vinyl text
Font: Univers Std 67 Bold Condensed
 (color: White)

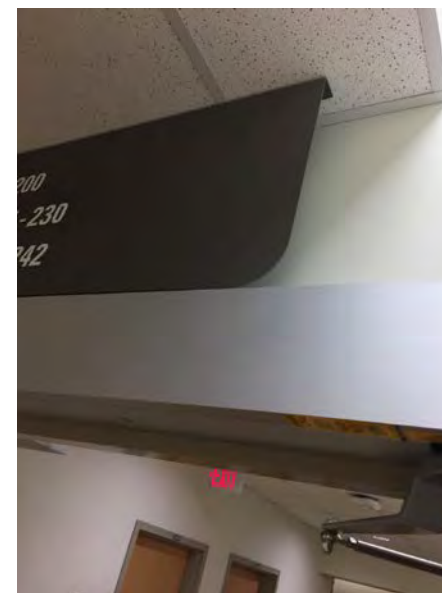
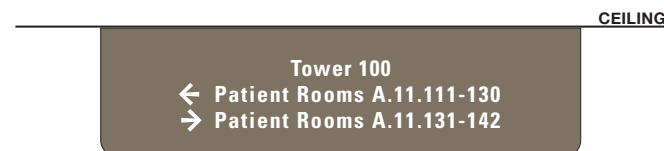

Existing Campus Example

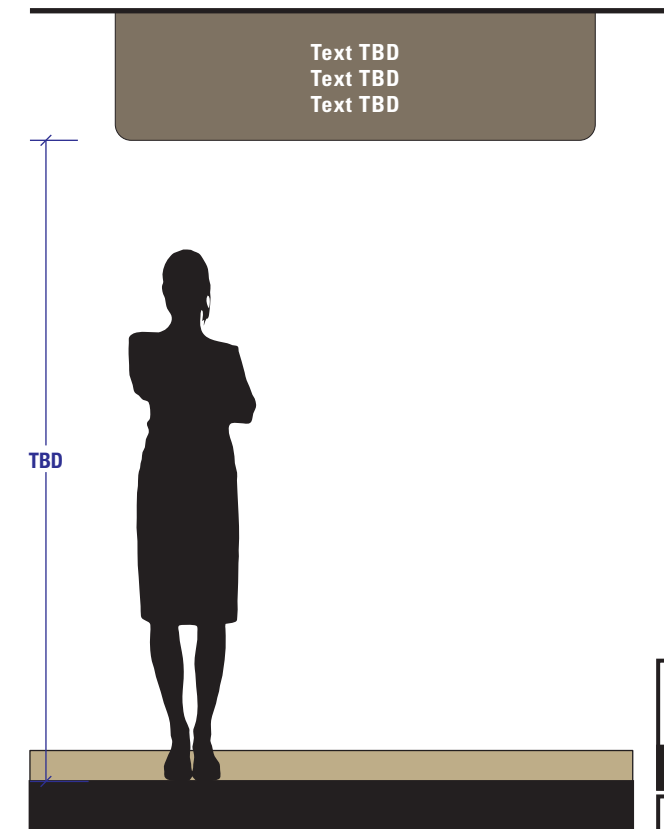

| |
|---|
| Drawing Title: OVERHEAD DIRECTIONAL (BACK OF HOUSE) |
| WAYFINDING |
| Sign Type SOD |

UK HealthCare Pavilion A – Back of House Overhead Directional (SOD)

Interior Signage | Design Intent Drawings – scale: 2"= 1'-0"

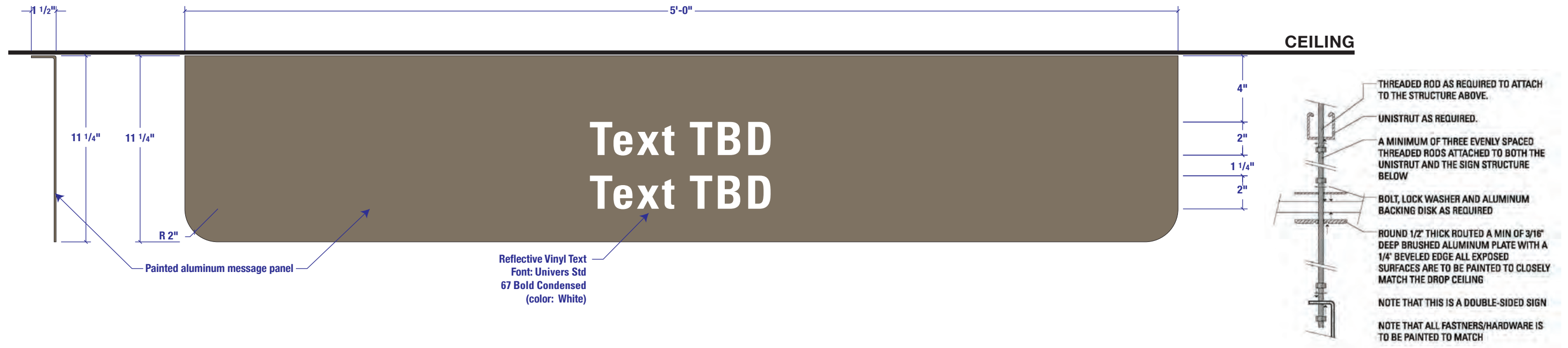

Back of House Overhead Directional (SOD)

NOTE: This can be a One or Two Sided Sign. Text is always centered.

5'-0"w x 11 1/4"h x 1/8"t painted aluminum message panel

Overall sign is painted **SHERWIN-WILLIAMS PAINT #SW0038 LIBRARY PEWTER SATIN FINISH**

Reflective vinyl text
Font: **Univers Std 67 Bold Condensed**
(color: White)

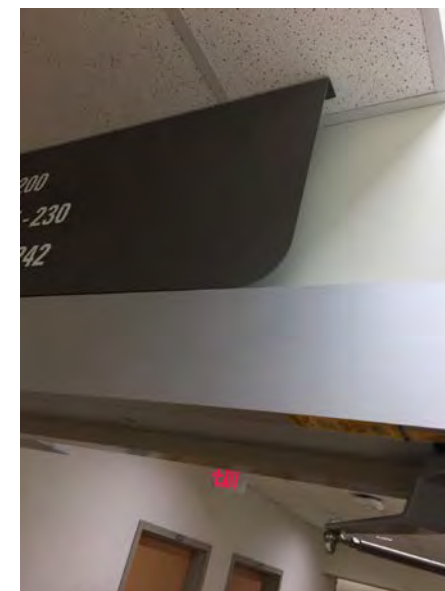
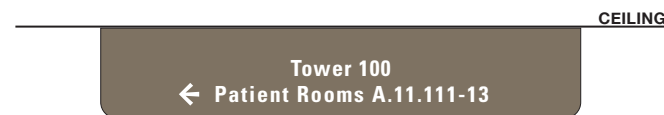

Existing Campus Example

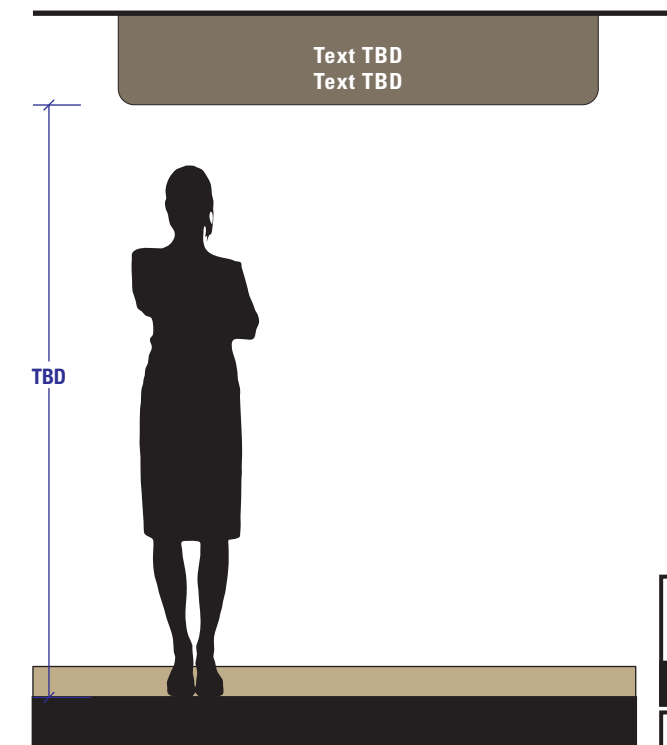

Drawing Title:
**OVERHEAD DIRECTIONAL
(BACK OF HOUSE)**

WAYFINDING

Sign Type
SOD

UK HealthCare Pavilion A – Back of House Typical Blade Sign (SBD)

Interior Signage | Design Intent Drawings – scale: 3"= 1'-0"

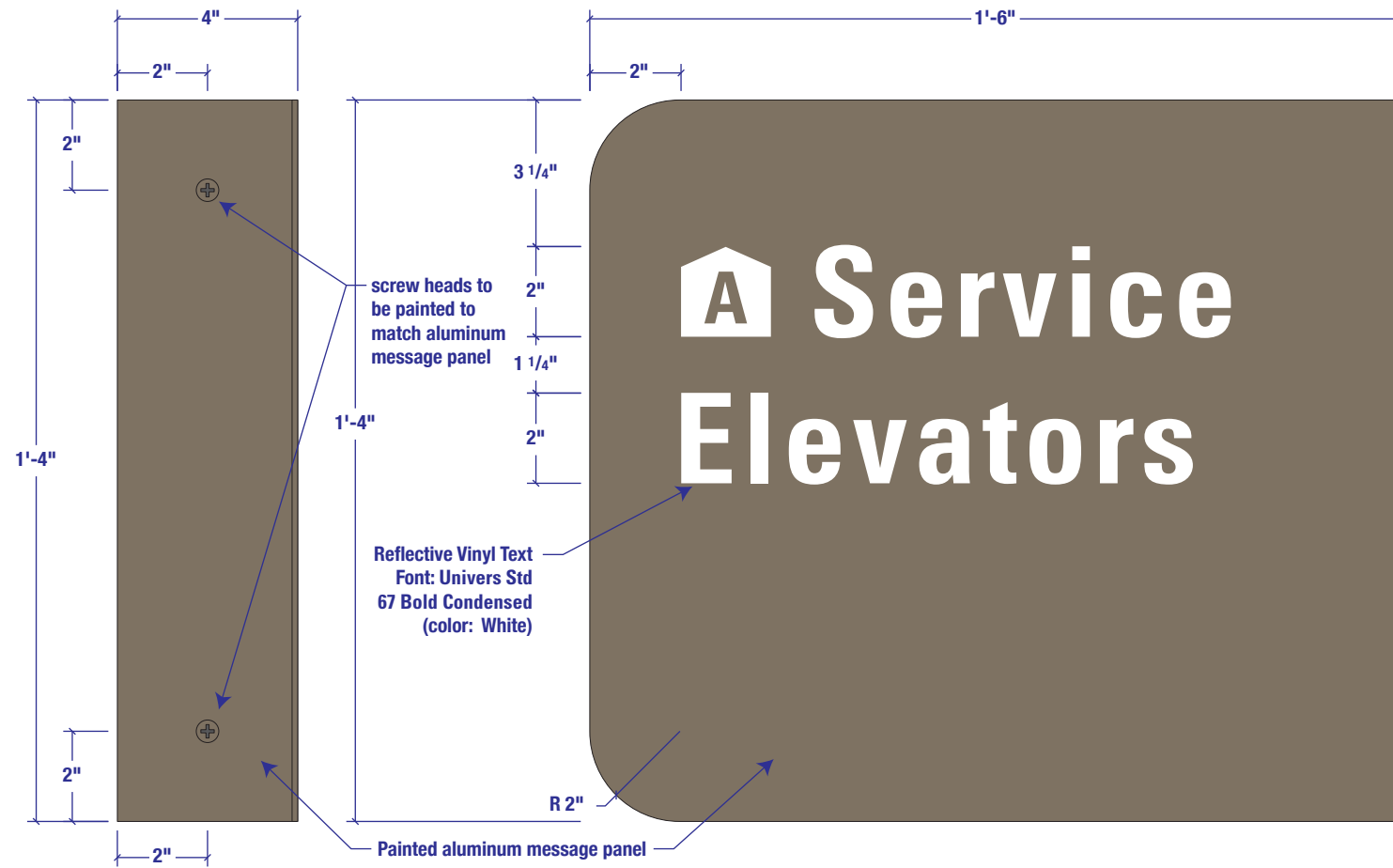

outside edge elevation

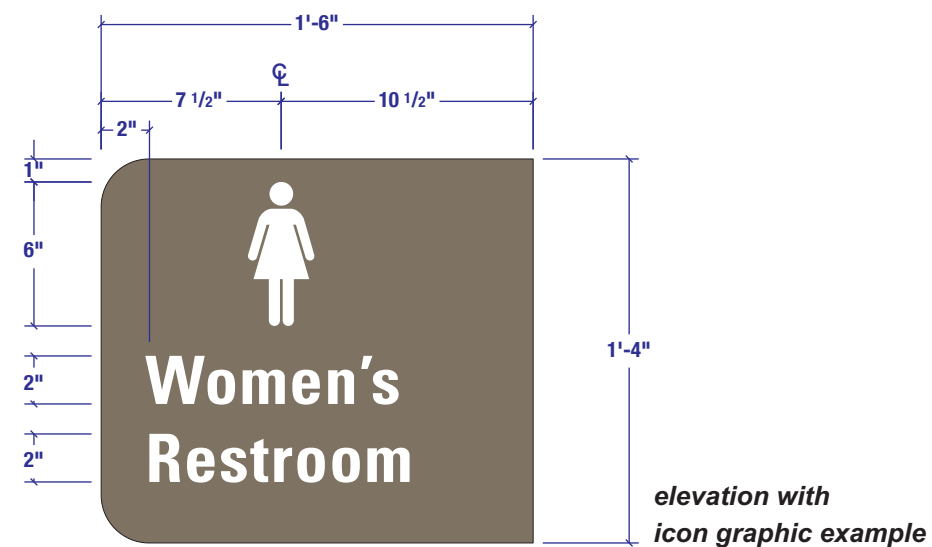

elevation with icon graphic example

Back of House Typical Blade Sign (SBD)

NOTE: This can be a One or Two Sided Sign. Text is always justified to the outside edge.

1'-6"w x 1'-4"h x 1/8"t painted aluminum message panel. Screw heads to be painted to match message panel.

Overall sign is painted **SHERWIN-WILLIAMS PAINT #SW0038 LIBRARY PEWTER SATIN FINISH**

Reflective vinyl text
Font: Univers Std 67 Bold Condensed
(color: White)

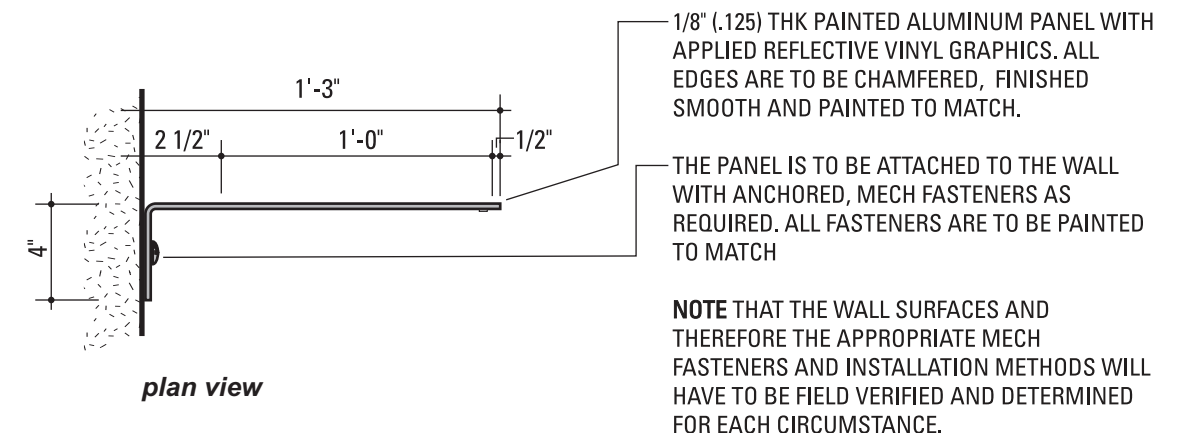

plan view



Existing Campus Example

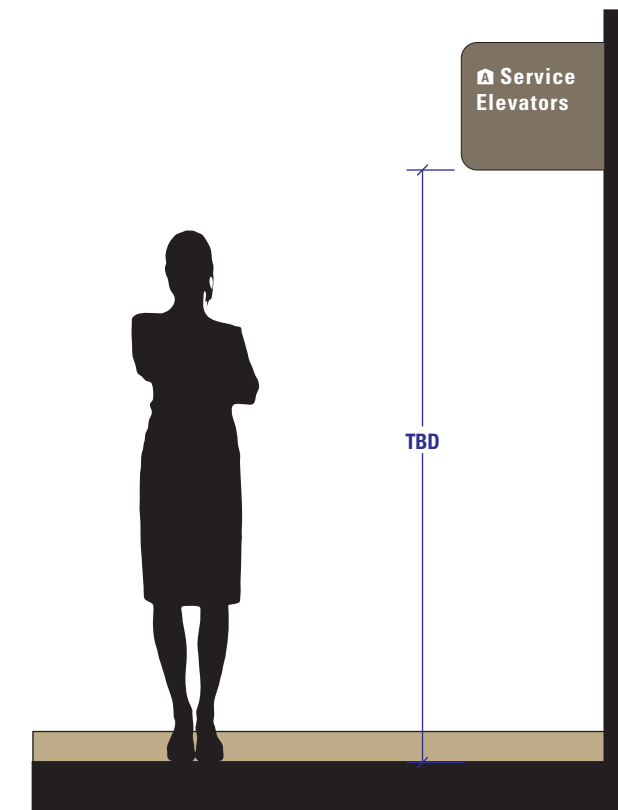

scale 1/2" = 1'-0"

Drawing Title:
TYPICAL BLADE SIGN
(BACK OF HOUSE)
WAYFINDING
Sign Type
SBD

UK HealthCare Pavilion A – Primary Room Identifier (RID)

Interior Signage | Design Intent Drawings – scale: 6"= 1'-0"

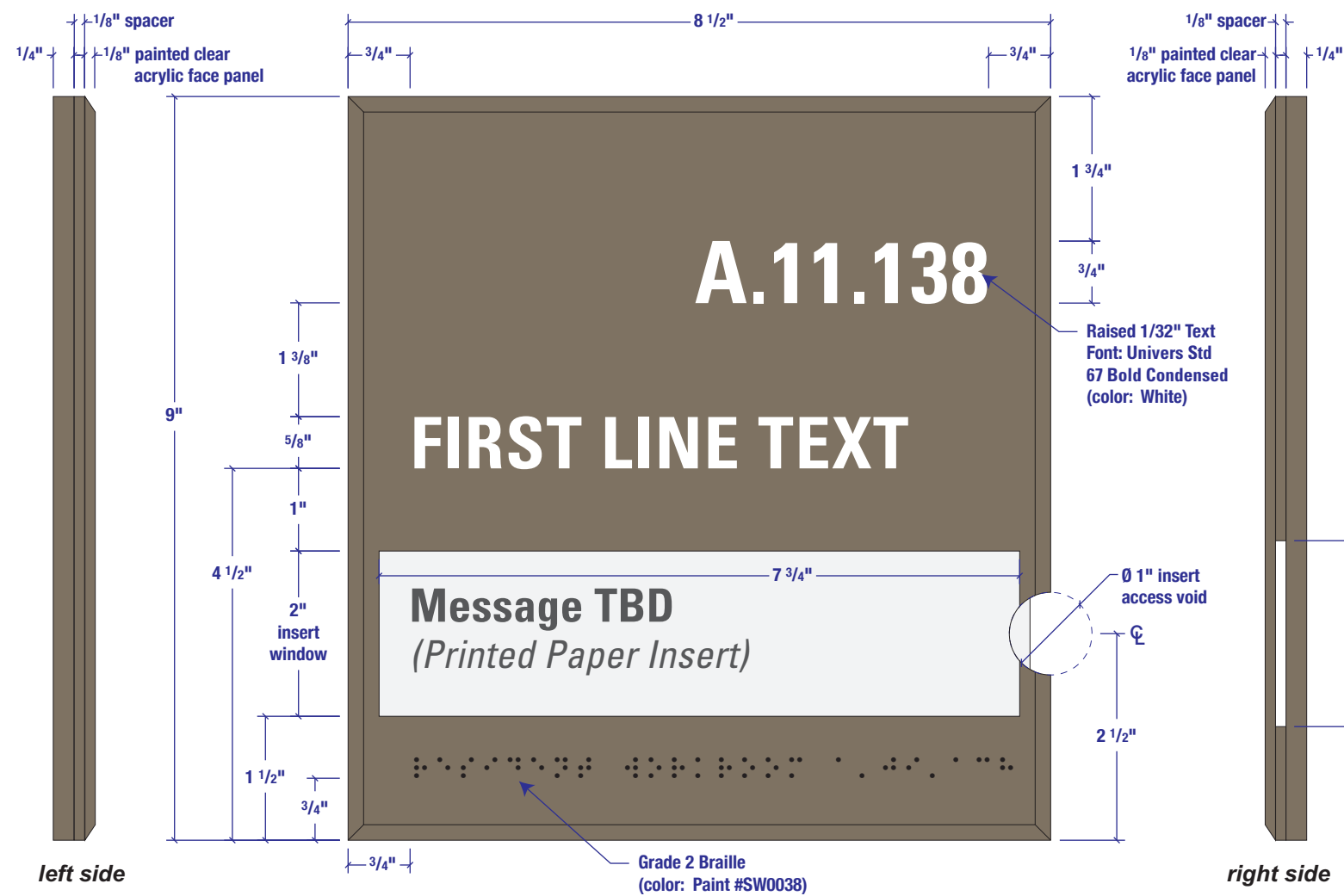

Primary Room Identifier (RID)

8.5"w x 9"h plaque with .125 beveled edged face panel

1/8" clear acrylic face panel

1/8" right sided paper insert void with 1" diameter thumb void. The increased depth and thumb void will help with daily updating of various inserts.

Overall sign is painted **SHERWIN-WILLIAMS PAINT #SW0038 LIBRARY PEWTER SATIN FINISH** with masked areas for the insert clear window.

1/32" (or 1/16") raised white text
Font: Univers Std 67 Bold Condensed (color: White)

Grade 2 Braille **SHERWIN-WILLIAMS PAINT #SW0038 LIBRARY PEWTER SATIN FINISH**

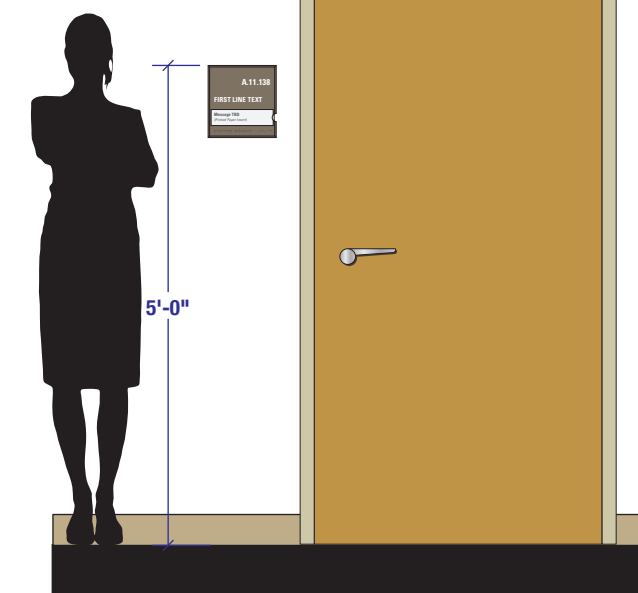
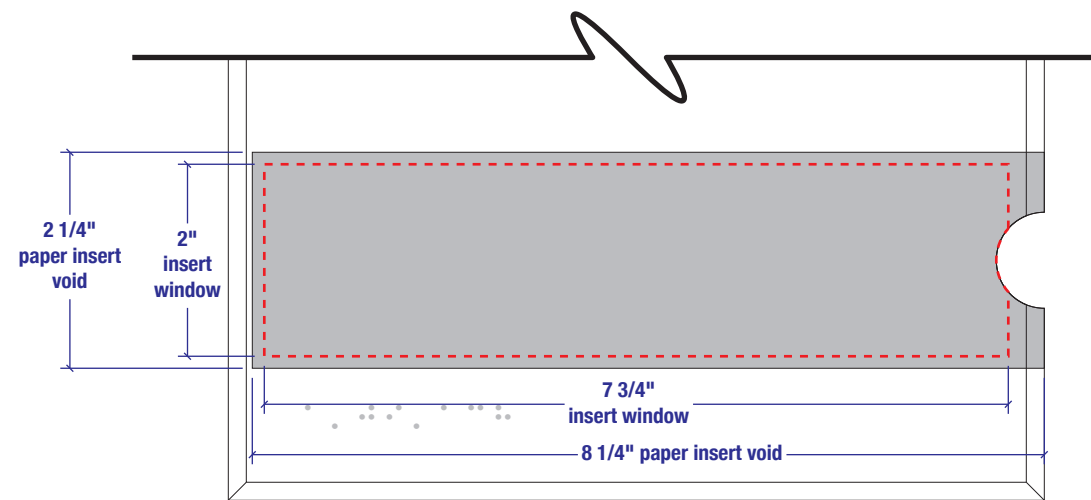
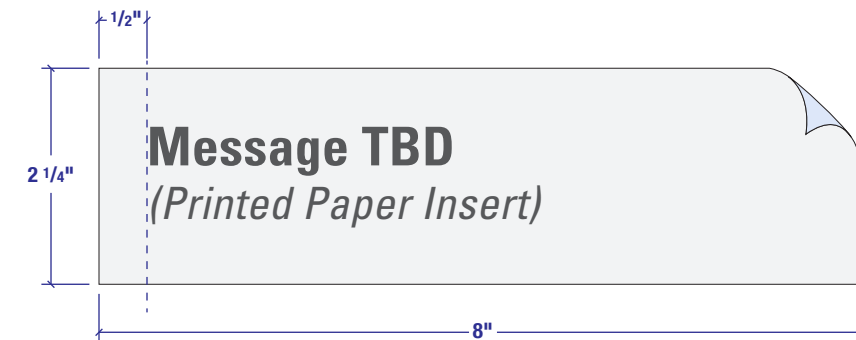

Drawing Title:
PRIMARY ROOM IDENTIFIER (PUBLIC LEVEL)
WAYFINDING
 Sign Type
RID

UK HealthCare Pavilion A – Primary Room Identifier (RID)

Interior Signage | Design Intent Drawings – scale: 6"= 1'-0"

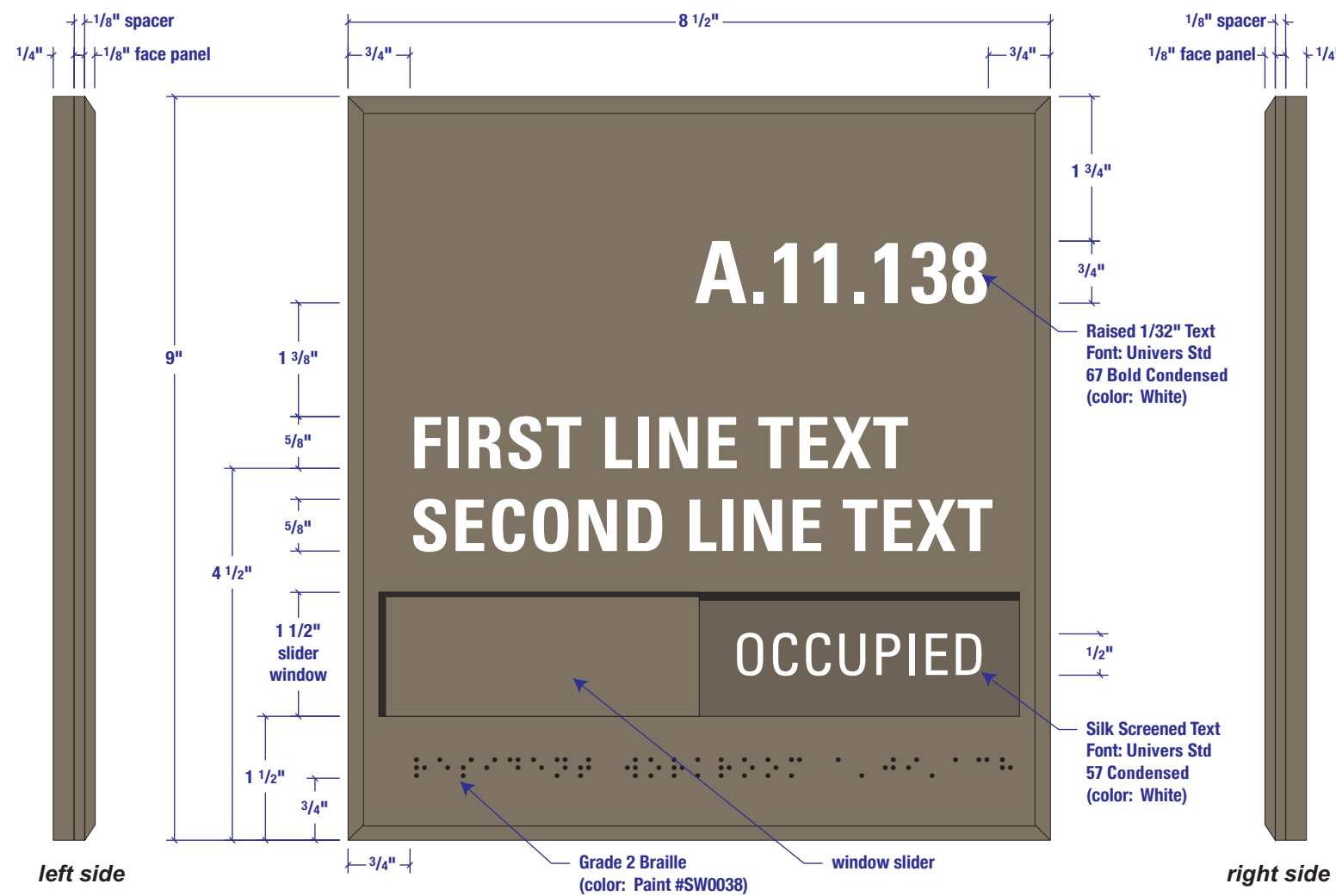

Primary Room Identifier (RID)

8.5"w x 9"h plaque with .125 beveled edged face panel

Silk screened white text applied to 1/4" back panel "OPEN" and "OCCUPIED" with window slider which can slide left and right horizontally.

Font: Univers Std 57 Condensed
 (color: White)

Overall sign is painted **SHERWIN-WILLIAMS PAINT #SW0038 LIBRARY PEWTER SATIN FINISH**

1/32" (or 1/16") raised white text
Font: Univers Std 67 Bold Condensed
 (color: White)

Grade 2 Braille **SHERWIN-WILLIAMS PAINT #SW0038 LIBRARY PEWTER SATIN FINISH**

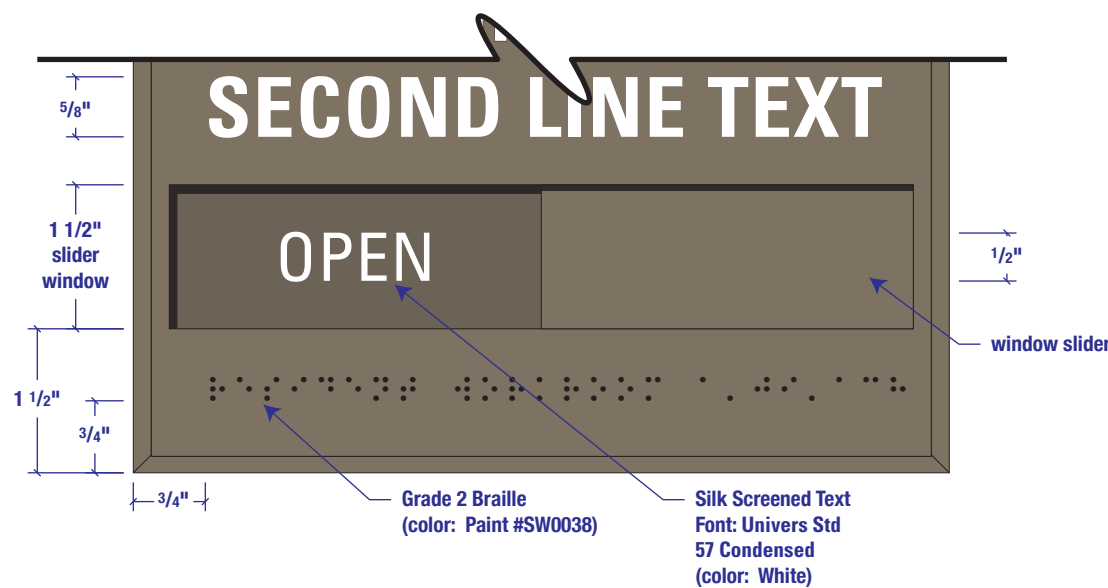

scale 1/2" = 1'-0"

| |
|--|
| Drawing Title: PRIMARY ROOM IDENTIFIER (PUBLIC LEVEL) WAYFINDING |
| Sign Type RID |

UK HealthCare Pavilion A – Primary Room Identifier (RID)

Interior Signage | Design Intent Drawings – scale: 6"= 1'-0"

Primary Room Identifier (RID)

8.5"w x 9"h plaque with .125 beveled edged face panel

Overall sign is painted **SHERWIN-WILLIAMS PAINT #SW0038 LIBRARY PEWTER SATIN FINISH**

1/32" (or 1/16") raised white text

Font: Univers Std 67 Bold Condensed
(color: White)

Grade 2 Braille **SHERWIN-WILLIAMS PAINT #SW0038 LIBRARY PEWTER SATIN FINISH**

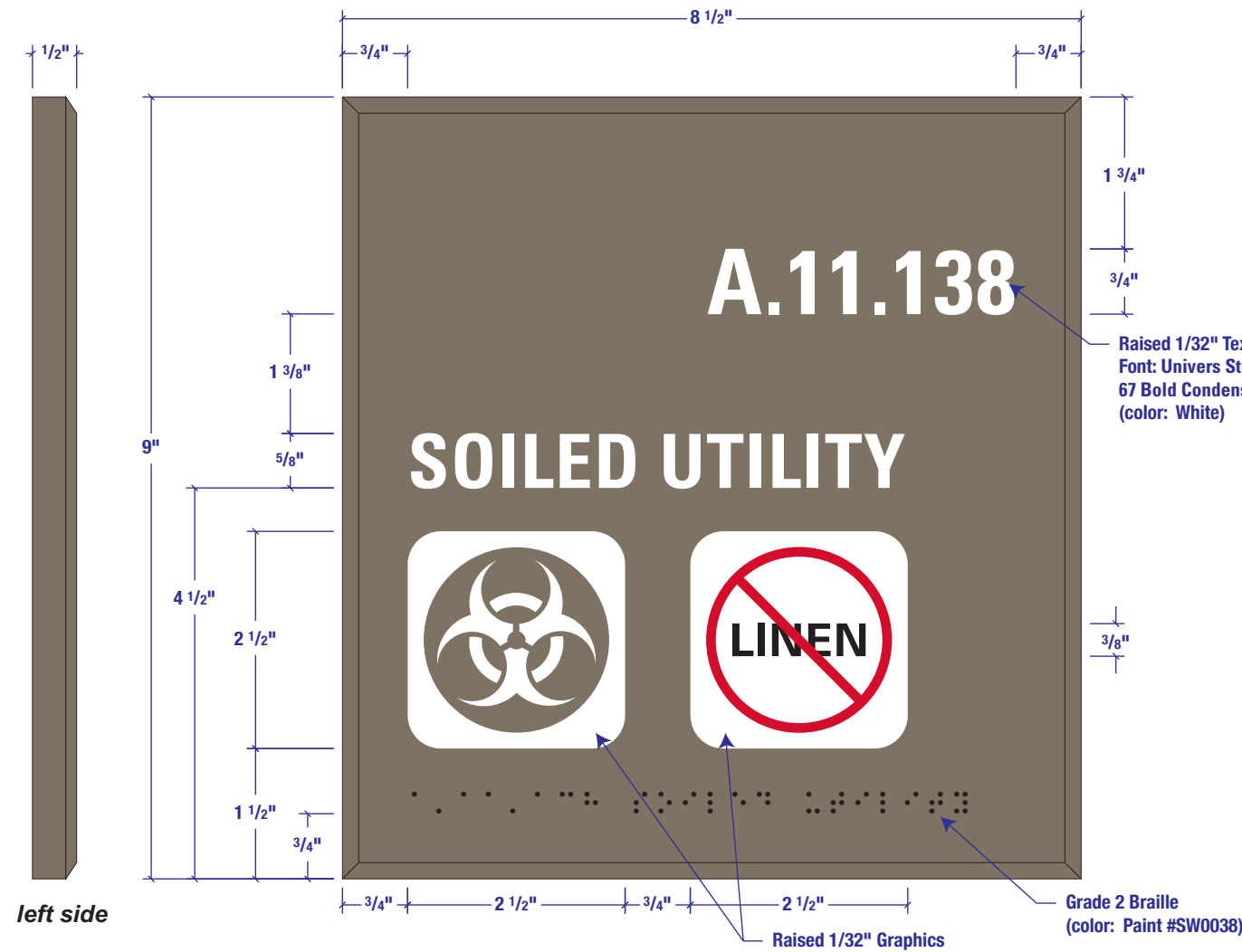

Existing Campus Example

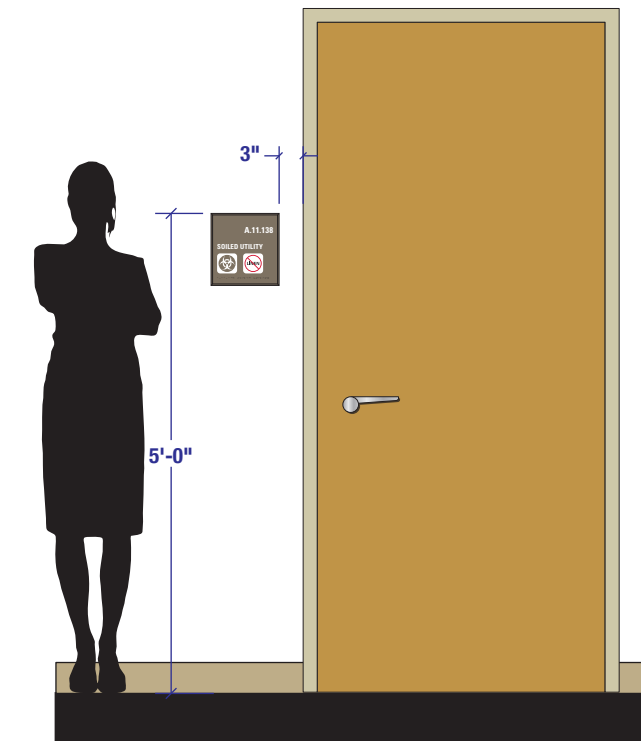

scale 1/2" = 1'-0"

| |
|--|
| Drawing Title: PRIMARY ROOM IDENTIFIER (PUBLIC LEVEL) WAYFINDING |
| Sign Type RID |

UK HealthCare Pavilion A – Primary Room Identifier (RID)

Interior Signage | Design Intent Drawings – scale: 6"= 1'-0"

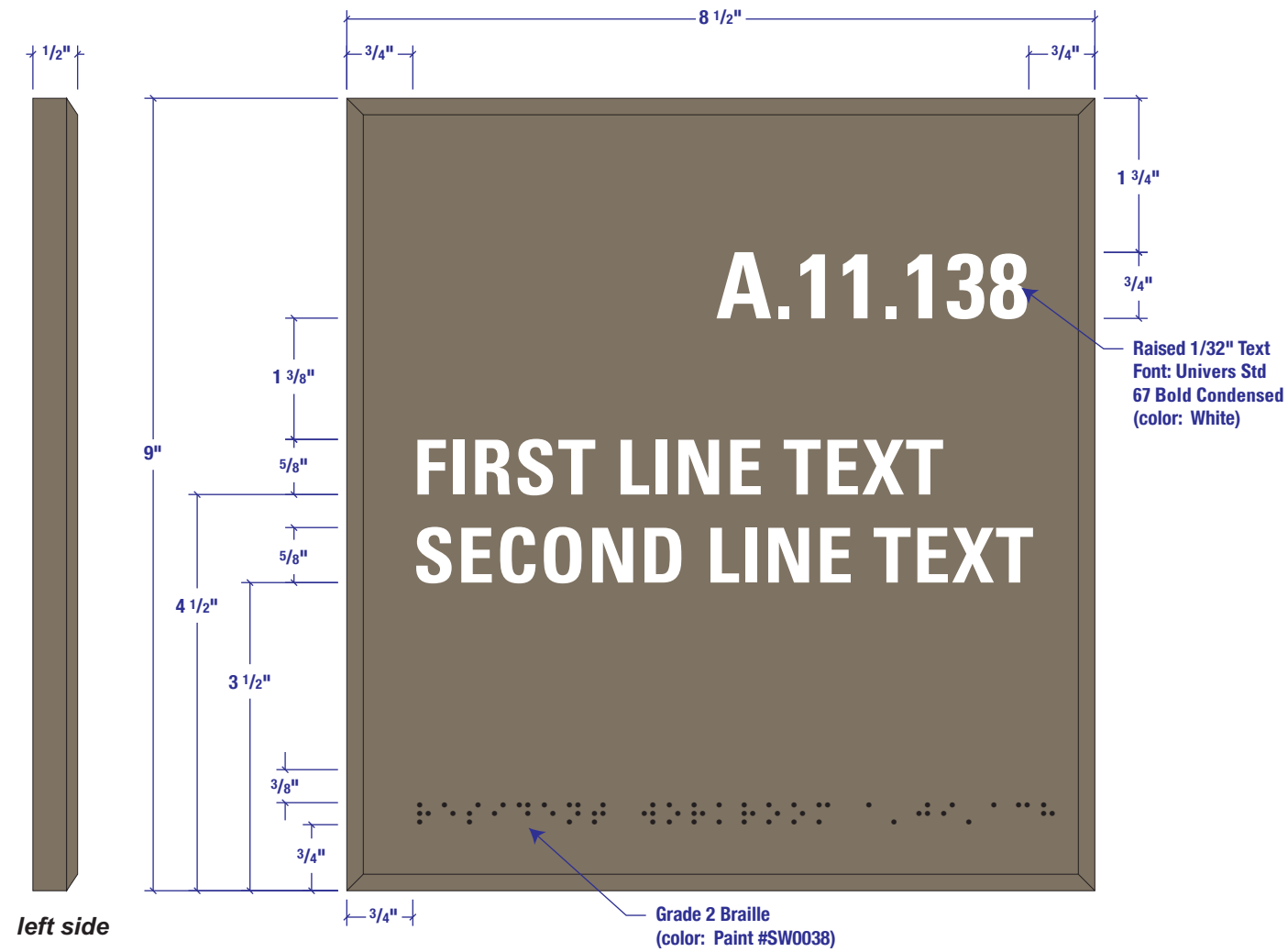

Primary Room Identifier (RID)

8.5"w x 9"h plaque with .125 beveled edged face panel

Overall sign is painted **SHERWIN-WILLIAMS PAINT #SW0038 LIBRARY PEWTER SATIN FINISH**

1/32" (or 1/16") raised white text

Font: Univers Std 67 Bold Condensed
(color: White)

Grade 2 Braille **SHERWIN-WILLIAMS PAINT #SW0038 LIBRARY PEWTER SATIN FINISH**



Existing Campus Example

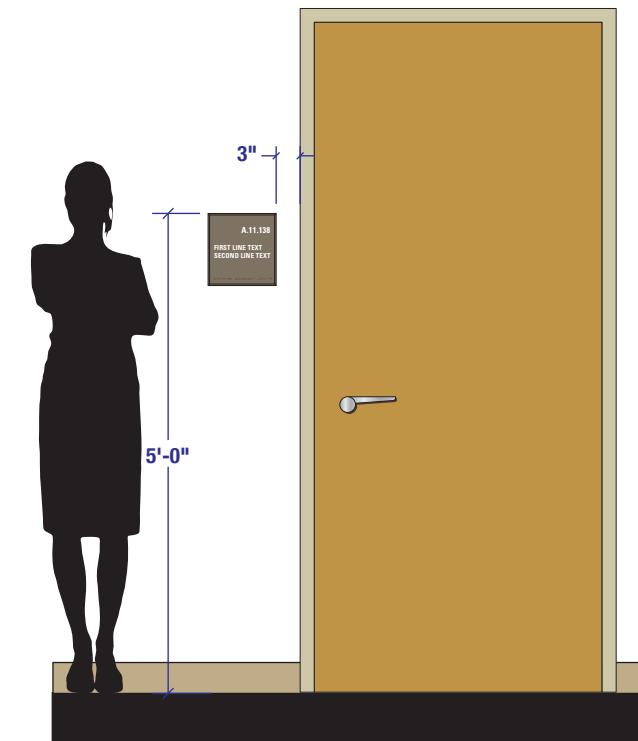

scale 1/2" = 1'-0"

| |
|---|
| Drawing Title: PRIMARY ROOM IDENTIFIER (PUBLIC LEVEL) |
| WAYFINDING |
| Sign Type RID |

UK HealthCare Pavilion A – Primary Room Identifier (RID)

Interior Signage | Design Intent Drawings – scale: 6"= 1'-0"

Primary Room Identifier (RID)

8.5"w x 9"h plaque with .125 beveled edged face panel

Overall sign is painted **SHERWIN-WILLIAMS PAINT #SW0038 LIBRARY PEWTER SATIN FINISH**

1/32" (or 1/16") raised white text

Font: Univers Std 67 Bold Condensed
(color: White)

Grade 2 Braille **SHERWIN-WILLIAMS PAINT #SW0038 LIBRARY PEWTER SATIN FINISH**

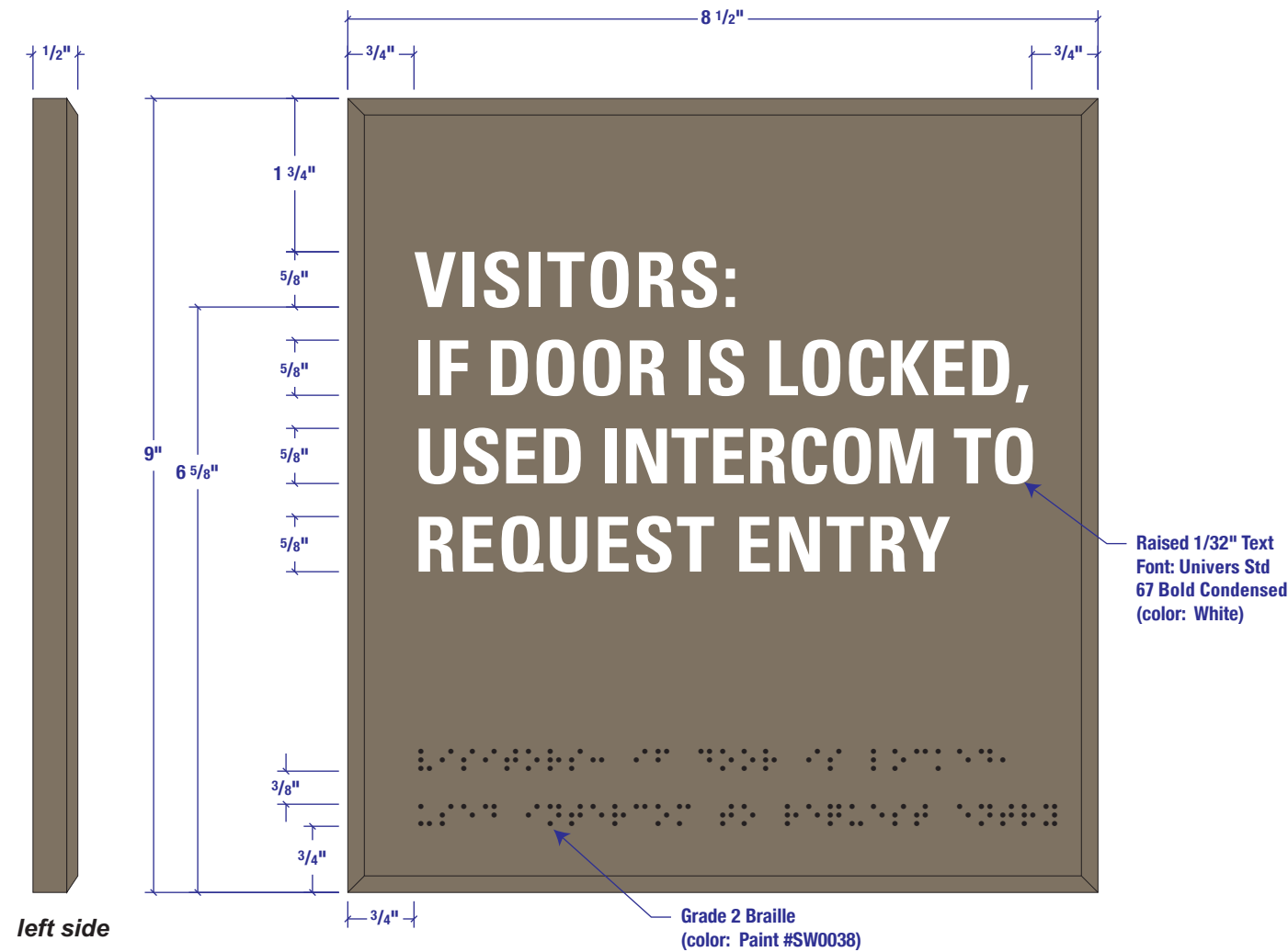

Raised 1/32" Text
Font: Univers Std
67 Bold Condensed
(color: White)

Grade 2 Braille
(color: Paint #SW0038)

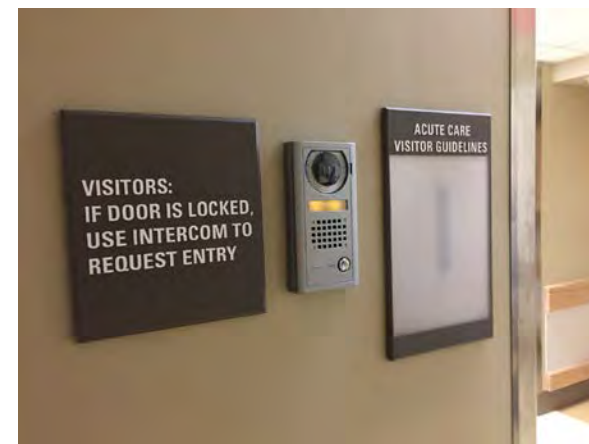

Existing Campus Example

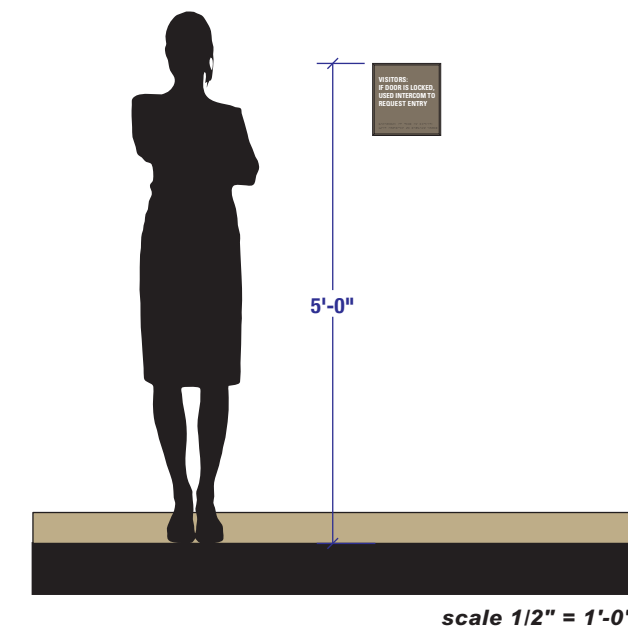

| |
|--|
| Drawing Title: PRIMARY ROOM IDENTIFIER (PUBLIC LEVEL) WAYFINDING |
| Sign Type RID |

UK HealthCare Pavilion A – Secondary Room Identifier (SID)

Interior Signage | Design Intent Drawings – scale: 6"= 1'-0"

Secondary Room Identifier (SID)

8.5"w x 4"h plaque

Overall sign is painted **SHERWIN-WILLIAMS PAINT #SW0038 LIBRARY PEWTER SATIN FINISH**

1/32" (or 1/16") raised white text

Font: Univers Std 67 Bold Condensed
(color: White)

Grade 2 Braille **SHERWIN-WILLIAMS PAINT #SW0038 LIBRARY PEWTER SATIN FINISH**

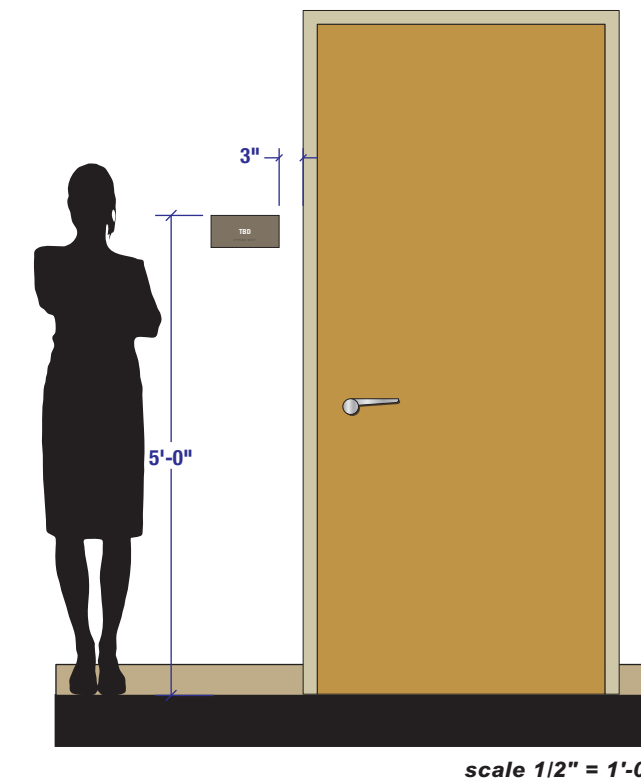
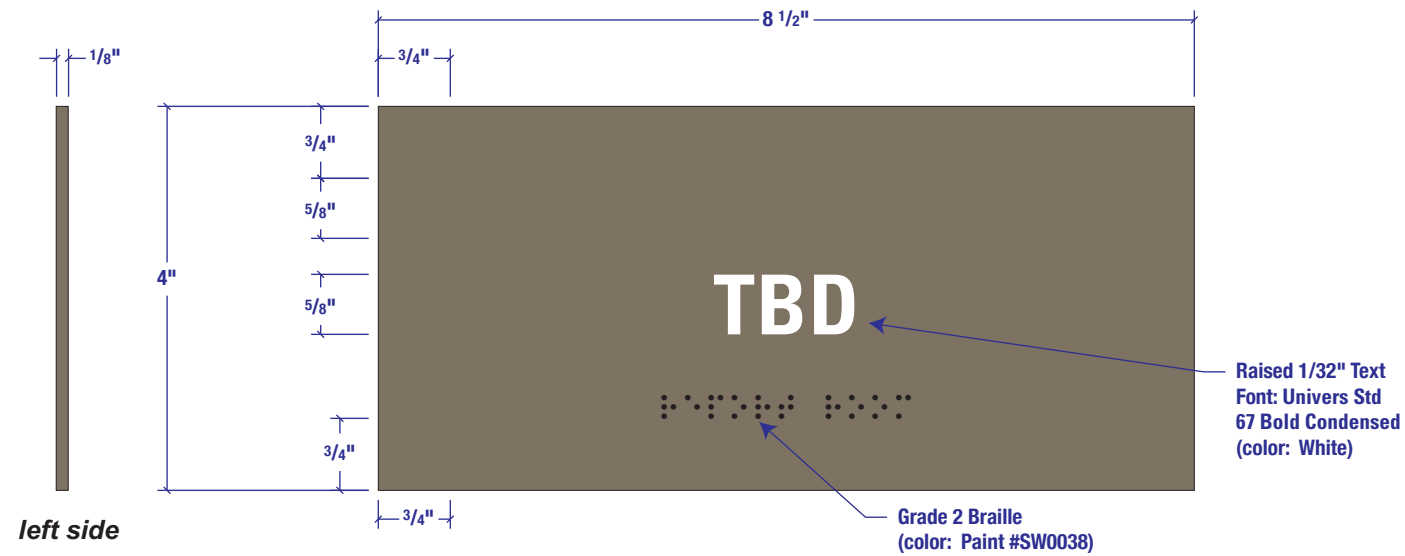

| |
|---|
| Drawing Title: SECONDARY ROOM IDENTIFIER (PUBLIC LEVEL) |
| WAYFINDING |
| Sign Type SID |

UK HealthCare Pavilion A – Information with Insert (INFIST)

Interior Signage | Design Intent Drawings – scale: 4"= 1'-0"

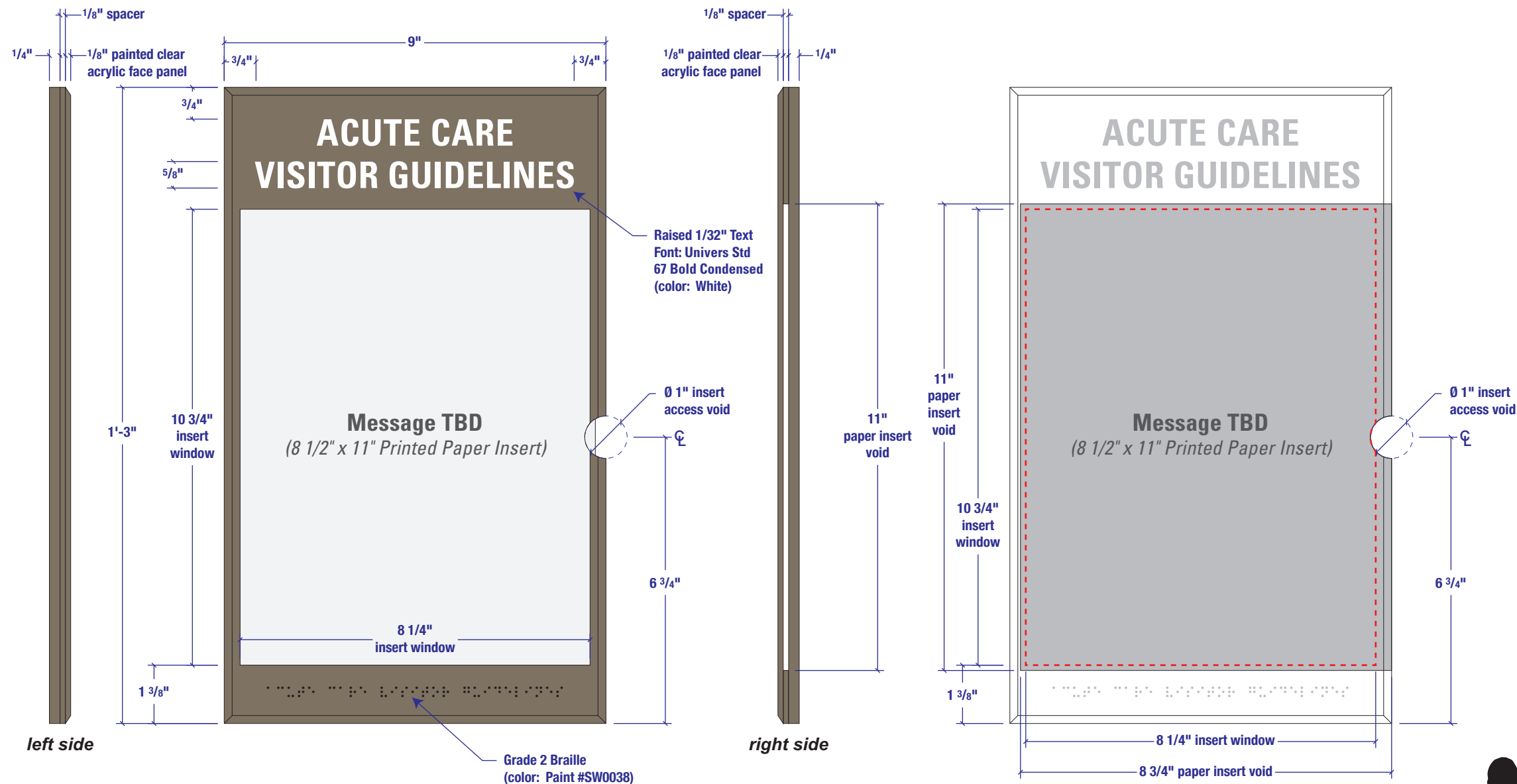

Information with Insert (INFIST)

9"w x 1'-3"h plaque with .125 beveled edged face panel

1/8" clear acrylic face panel

1/8" right sided paper insert void with 1" diameter thumb void. The increased depth and thumb void will help with daily updating of various inserts.

Overall sign is painted **SHERWIN-WILLIAMS PAINT #SW0038 LIBRARY PEWTER SATIN FINISH** with masked areas for the insert clear window.

1/32" (or 1/16") raised white text
Font: Univers Std 67 Bold Condensed (color: White)

Grade 2 Braille **SHERWIN-WILLIAMS PAINT #SW0038 LIBRARY PEWTER SATIN FINISH**

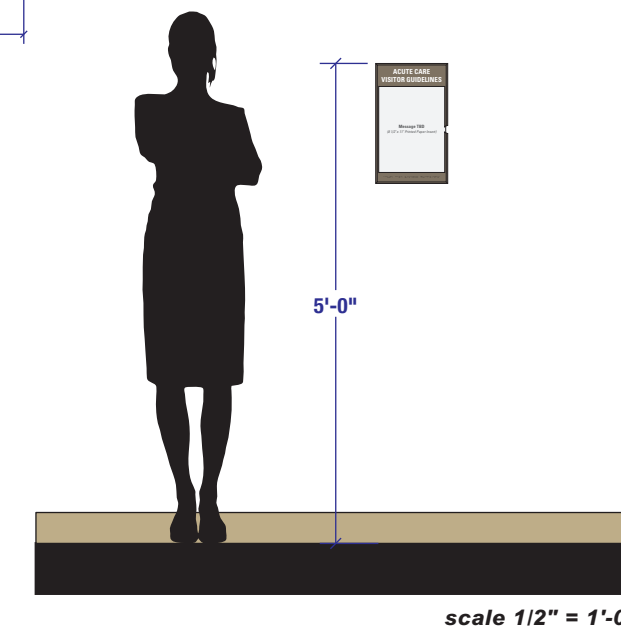
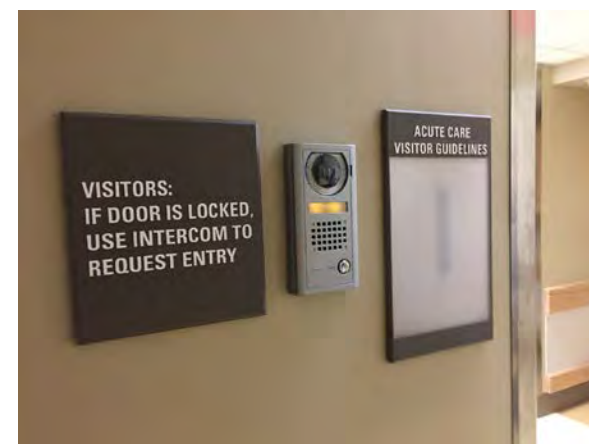

Drawing Title:
INFORMATION WITH INSERT (PUBLIC LEVEL)
WAYFINDING
 Sign Type
INFIST

UK HealthCare Pavilion A – Patient Room Identifier (PRI)

Interior Signage | Design Intent Drawings – scale: 6"= 1'-0"

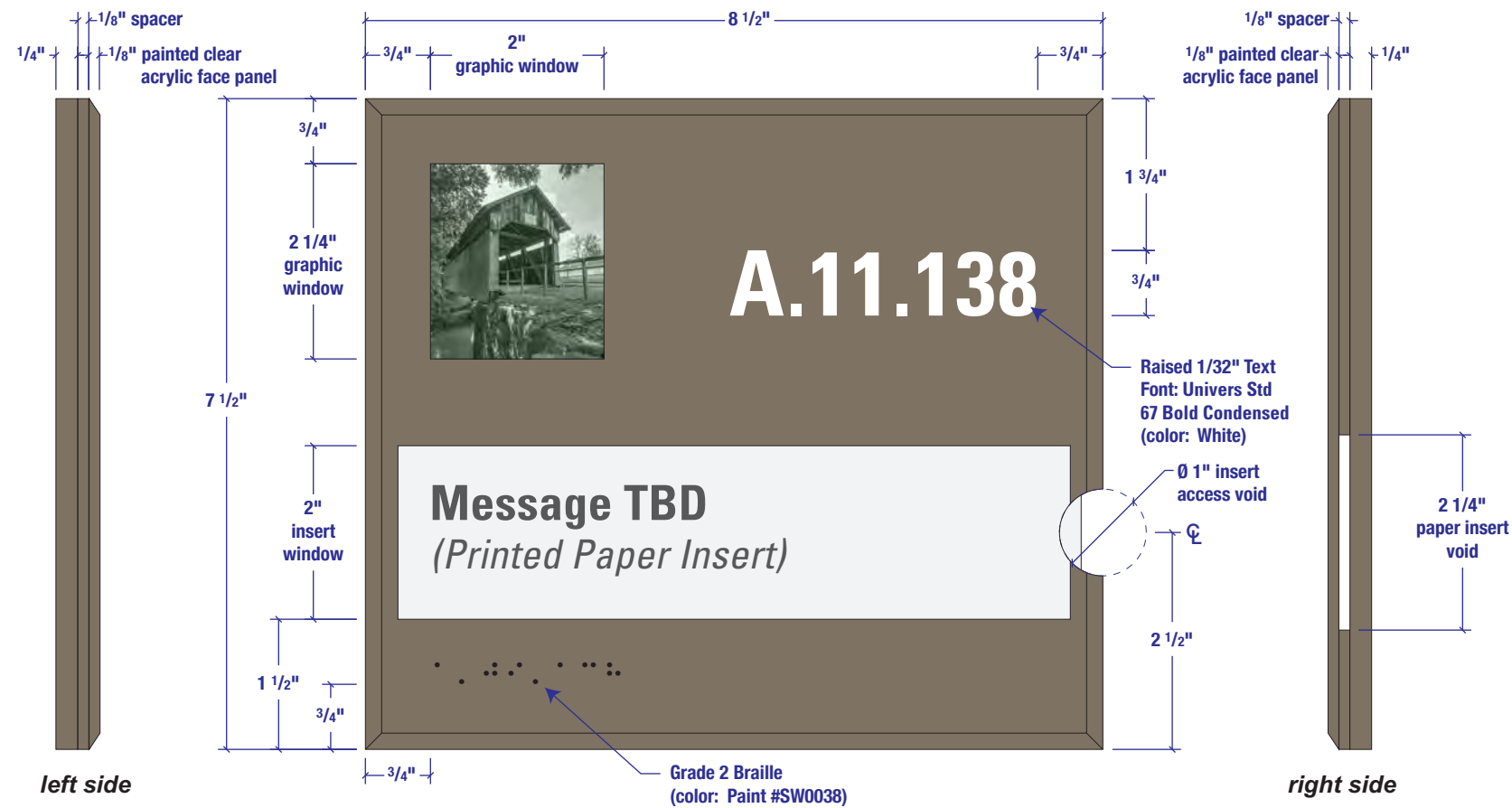

Patient Room Identifier (PRI)

8.5"w x 7.5"h plaque with .125 beveled edged face panel

1/8" clear acrylic face panel has a second surface applied graphic (graphic provided by owner)

1/8" right sided paper insert void with 1" diameter thumb void. The increased depth and thumb void will help with daily updating of the patient name inserts.

Overall sign is painted **SHERWIN-WILLIAMS PAINT #SW0038 LIBRARY PEWTER SATIN FINISH** with masked areas for the graphic and insert clear windows.

1/32" (or 1/16") raised white text
Font: Univers Std 67 Bold Condensed (color: White)

Grade 2 Braille **SHERWIN-WILLIAMS PAINT #SW0038 LIBRARY PEWTER SATIN FINISH**

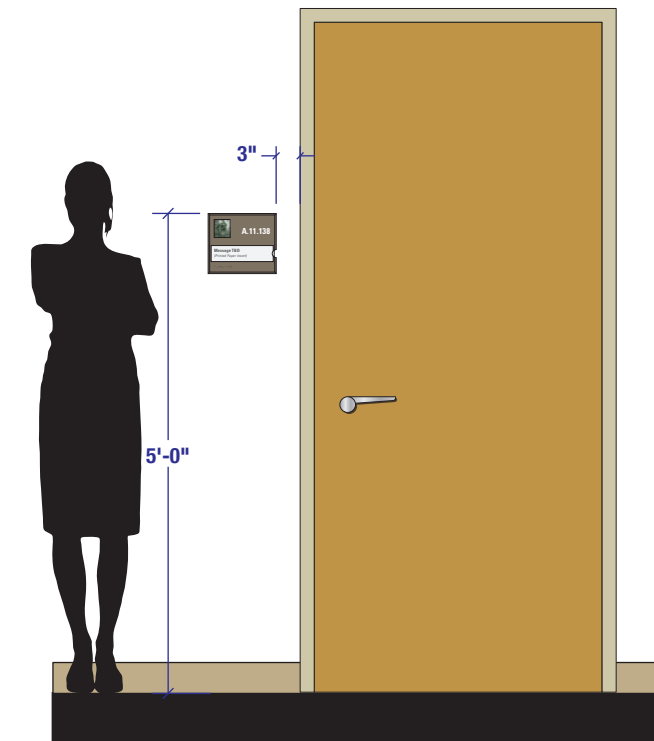
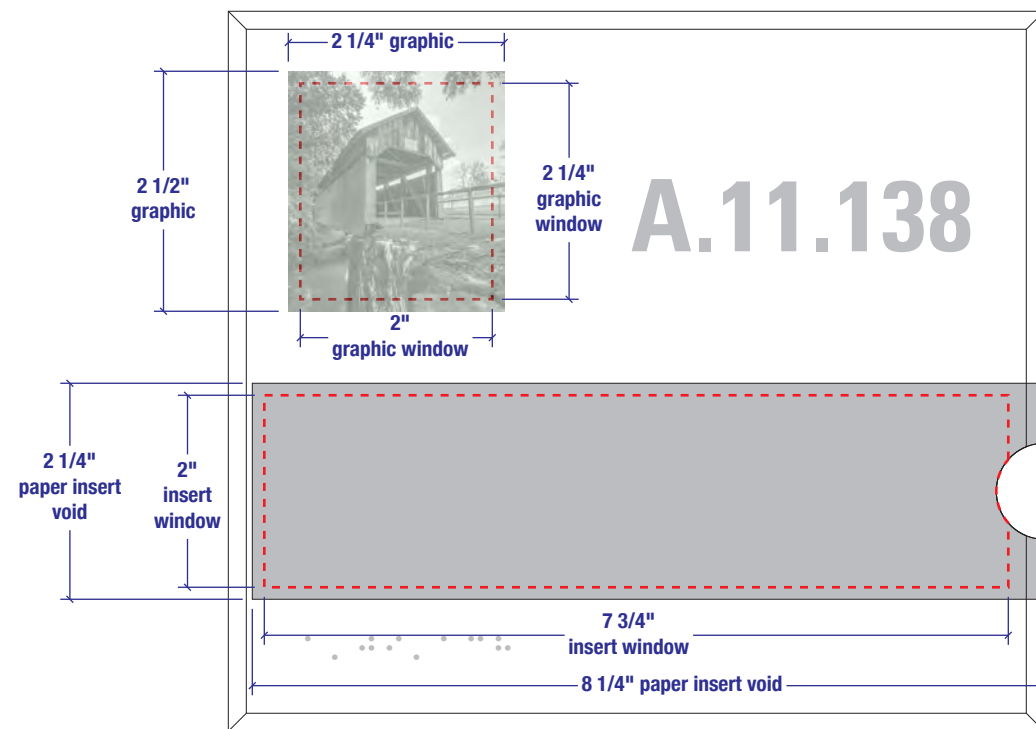
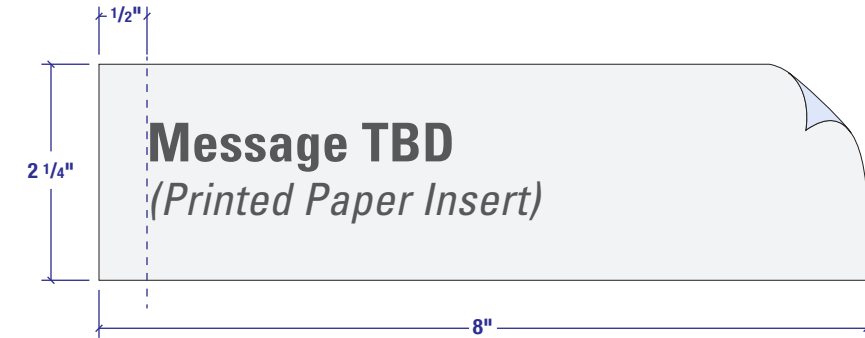

Drawing Title:
PATIENT ROOM IDENTIFIER (PUBLIC LEVEL)
WAYFINDING
 Sign Type
PRI

UK HealthCare Pavilion A – Patient Precautionary Signage

Interior Signage | Design Intent Drawings – scale: 3"= 1'-0"

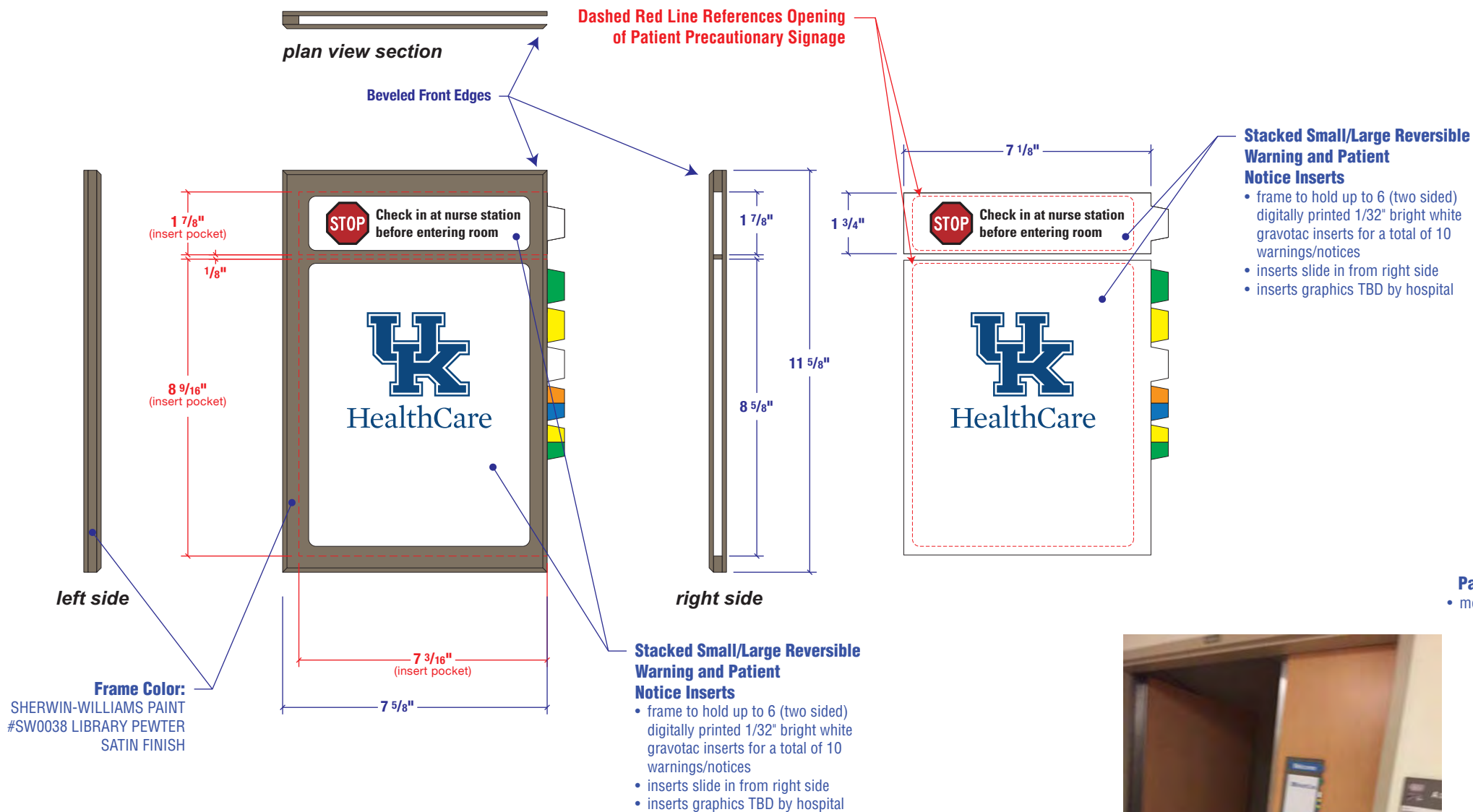

NOTE: Design uses same **Stacked Small/Large Reversible Warning and Patient Notice Inserts** as current interior patient alert insert signage within hospital

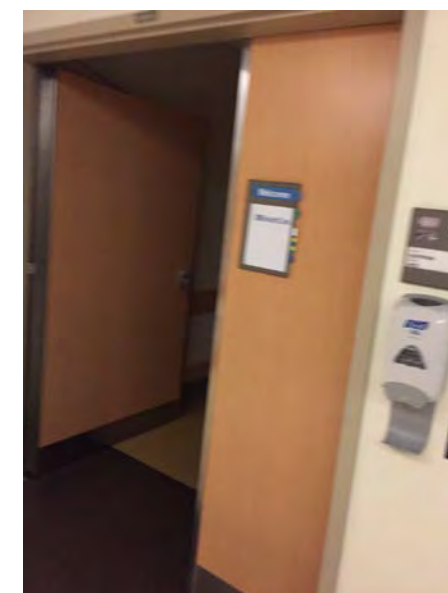

Existing Campus Example

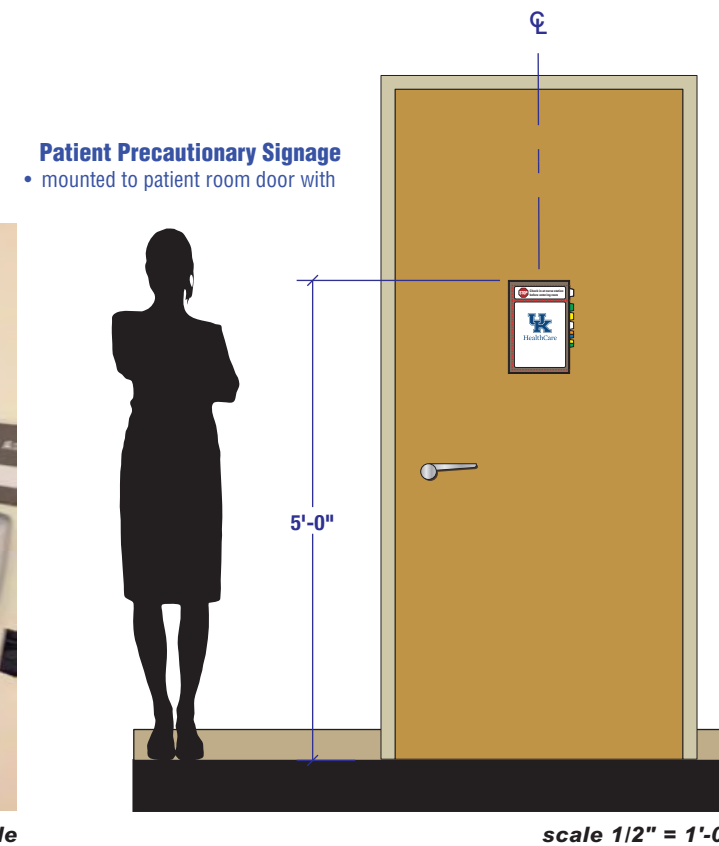

Drawing Title:
PATIENT PRECAUTIONARY SIGNAGE (PUBLIC LEVEL)
WAYFINDING
Sign Type
PREC

UK HealthCare Pavilion A – Patient Precautionary Signage

Interior Signage | 2-Sided Digitally Printed Insert Detail Drawings – scale: 3"= 1'-0"

Dashed Red Lines References Opening of Patient Precautionary Signage. Dashed Red Lines are not part of the graphic. **Do Not Print Dashed Red Lines.**

small insert 1 – side 1
Visually Impaired
Fall Risk

small insert 1 – side 2
Hearing Impaired
Use ASL Interpreter
Fall Risk

small insert 2 – side 1
Hard of Hearing
Fall Risk

small insert 2 – side 2
Limited English Proficiency
Use Interpreter

small insert 3 – side 1
Fall Risk

small insert 3 – side 2
No BP or Sticks

small insert 4 – side 1
No BP or Sticks

small insert 4 – side 2
24-Hour Urine

small insert 5 – side 1
Welcome

small insert 5 – side 2
NPO

small insert 6 – side 1
Check in at nurse station before entering room

small insert 6 – side 2
Out of Service

large insert 1 – side 1
STOP
Help us prevent the spread of infection!
Droplet Precautions
(In addition to Standard Precautions)
Hospital Staff: Perform Hand Hygiene, Wear Standard Mask, Close Door, Use Dedicated Equipment.
Visitors: Perform Hand Hygiene, Wear Standard Mask, Close Door.

large insert 1 – side 2
STOP
Help us prevent the spread of infection!
Contact Precautions
(In addition to Standard Precautions)
Hospital Staff: Perform Hand Hygiene, Wear Gown and Gloves, Use Dedicated Equipment.
Visitors: Perform Hand Hygiene, Wear Standard Mask, Close Door.

large insert 2 – side 1
STOP
Help us prevent the spread of infection!
Contact D Precautions
(In addition to Standard Precautions)
Hospital Staff: Wash Hands, Wear Gown and Gloves, Use Dedicated Equipment.
Visitors: Wash Hands, Wear Standard Mask, Close Door.

large insert 2 – side 2
STOP
Help us prevent the spread of infection!
Airborne Precautions
(In addition to Standard Precautions)
Hospital Staff: Perform Hand Hygiene, Wear N95 Respirator, Close Door, Use Dedicated Equipment.
Visitors: Perform Hand Hygiene, Wear Standard Mask, Close Door.

large insert 3 – side 1
STOP
Help us prevent the spread of infection!
Contact / Droplet Precautions
(In addition to Standard Precautions)
Hospital Staff: Perform Hand Hygiene, Wear Gown and Gloves, Wear Standard Mask, Close Door, Use Dedicated Equipment.
Visitors: Perform Hand Hygiene, Wear Standard Mask, Close Door.

large insert 3 – side 2
STOP
Help us prevent the spread of infection!
Contact D/Droplet Precautions
(In addition to Standard Precautions)
Hospital Staff: Wash Hands, Wear Gown and Gloves, Wear Standard Mask, Close Door, Use Dedicated Equipment.
Visitors: Wash Hands, Wear Standard Mask, Close Door.

large insert 4 – side 1
STOP
Help us prevent the spread of infection!
Contact D/Airborne Precautions
(In addition to Standard Precautions)
Hospital Staff: Wash Hands, Wear Gown and Gloves, Wear N95 Respirator, Close Door, Use Dedicated Equipment.
Visitors: Wash Hands, Wear Standard Mask, Close Door.

large insert 4 – side 2
STOP
Help us prevent the spread of infection!
Contact/Airborne Precautions
(In addition to Standard Precautions)
Hospital Staff: Perform Hand Hygiene, Wear Gown and Gloves, Wear N95 Respirator, Close Door, Use Dedicated Equipment.
Visitors: Perform Hand Hygiene, Wear Standard Mask, Close Door.

large insert 5 – side 1
STOP
Room Closed for Maintenance

large insert 5 – side 2
UK HealthCare

Dashed Red Lines References Opening of Patient Precautionary Signage. Dashed Red Lines are not part of the graphic. **Do Not Print Dashed Red Lines.**

Stacked Small/Large Reversible Warning and Patient Notice Inserts
• 6 (two sided) digitally printed 1/32" bright white gravotac inserts for a total of 10 warnings/notices

Drawing Title:
PATIENT PRECAUTIONARY SIGNAGE (PUBLIC LEVEL)
WAYFINDING
Sign Type
PREC

UK HealthCare Pavilion A – Public Restroom Identifier (RRS)

Interior Signage | Design Intent Drawings – scale: 6"= 1'-0"

Men's Restroom Identifier (RRS)

8.5"w x 11.5"h plaque with .125 beveled edged face panel

Overall sign is painted **SHERWIN-WILLIAMS PAINT #SW0038 LIBRARY PEWTER SATIN FINISH**

1/32" (or 1/16") raised white text

Font: Univers Std 67 Bold Condensed
(color: White)

Grade 2 Braille **SHERWIN-WILLIAMS PAINT #SW0038 LIBRARY PEWTER SATIN FINISH**

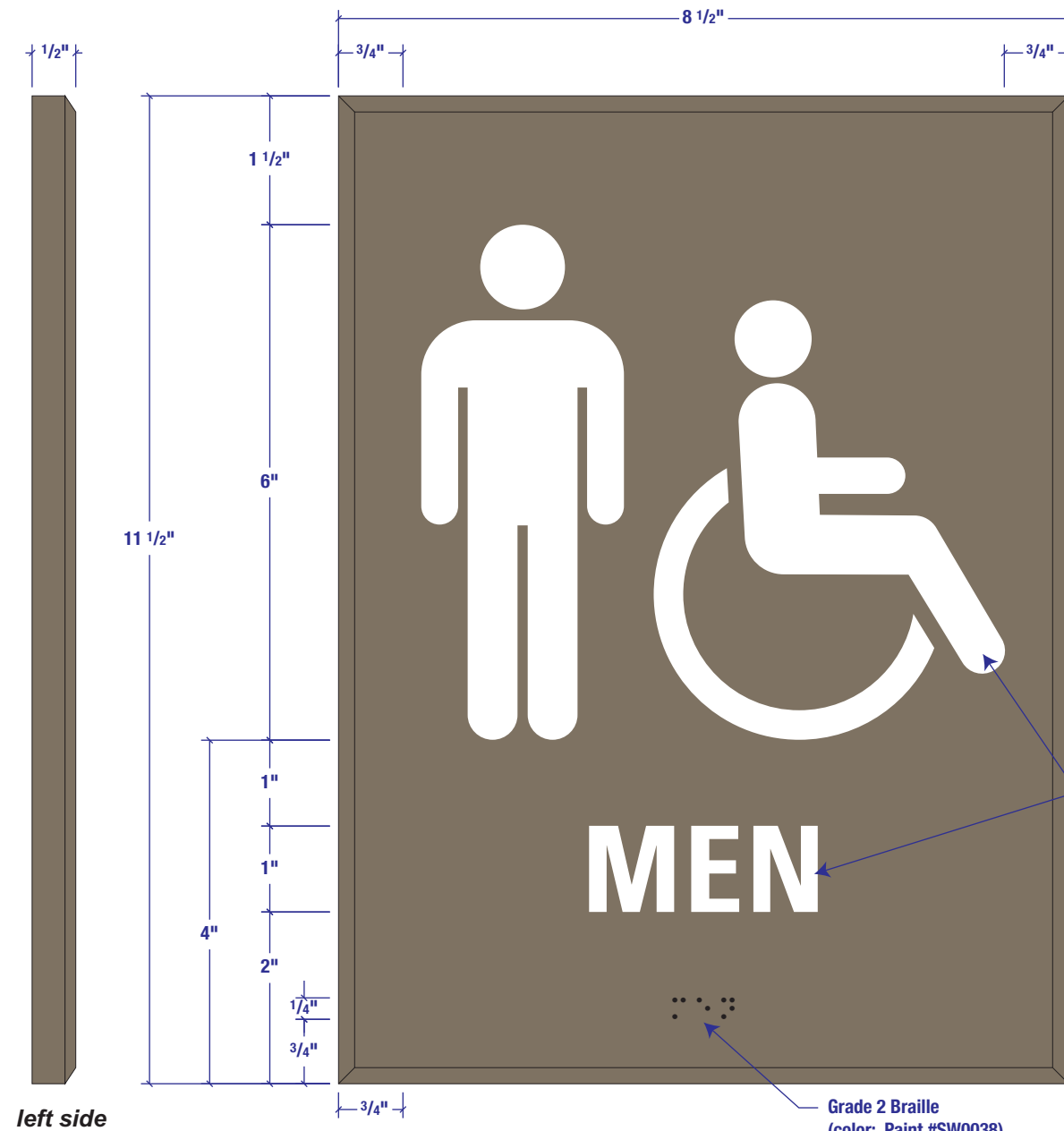

Existing Campus Example

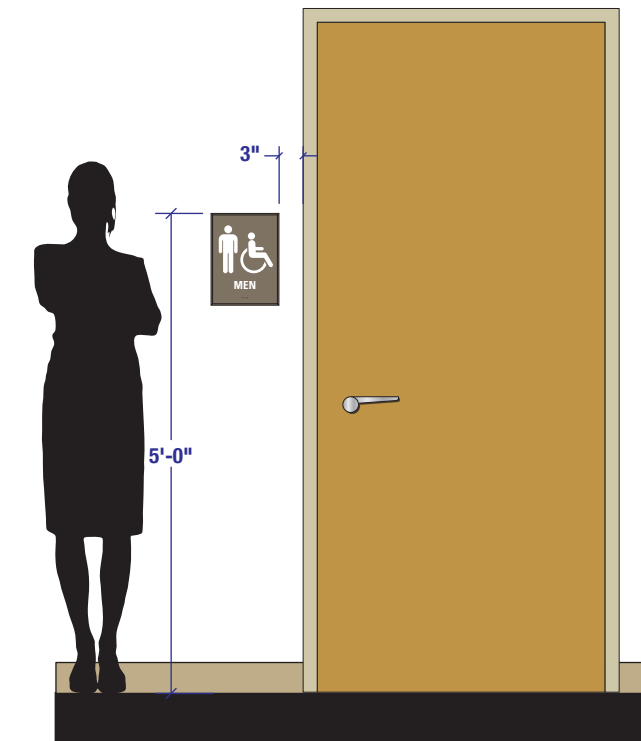

Drawing Title:
**MEN'S RESTROOM
SIGN (PUBLIC LEVEL)**
WAYFINDING
Sign Type
RRS

UK HealthCare Pavilion A – Public Restroom Identifier (RRS)

Interior Signage | Design Intent Drawings – scale: 6"= 1'-0"

Women's Restroom Identifier (RRS)

8.5"w x 11.5"h plaque with .125 beveled edged face panel

Overall sign is painted **SHERWIN-WILLIAMS PAINT #SW0038 LIBRARY PEWTER SATIN FINISH**

1/32" (or 1/16") raised white text

Font: Univers Std 67 Bold Condensed
(color: White)

Grade 2 Braille **SHERWIN-WILLIAMS PAINT #SW0038 LIBRARY PEWTER SATIN FINISH**

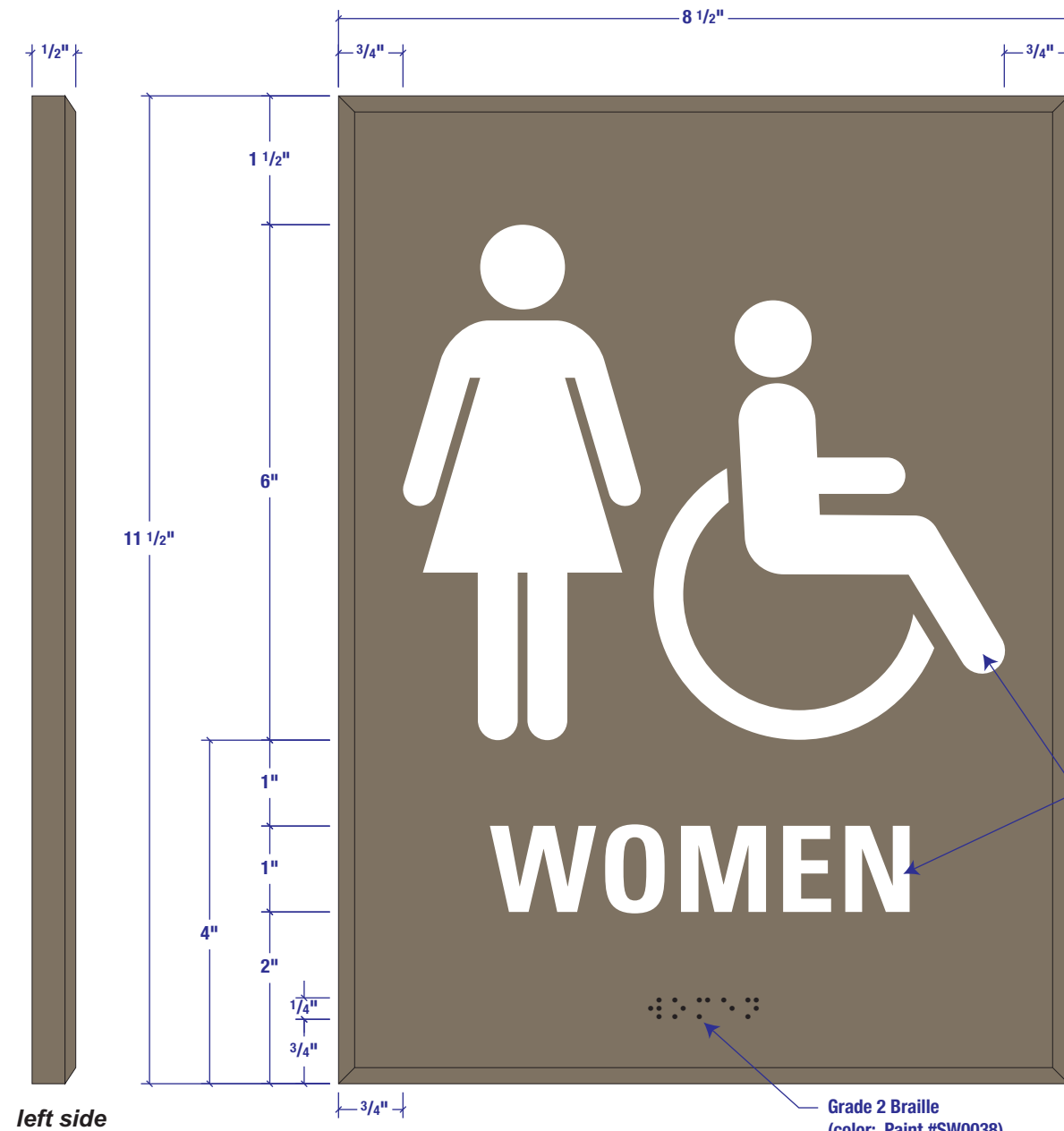

Raised 1/32" Text and Icons
Font: Univers Std
67 Bold Condensed
(color: White)

Grade 2 Braille
(color: Paint #SW0038)



Existing Campus Example

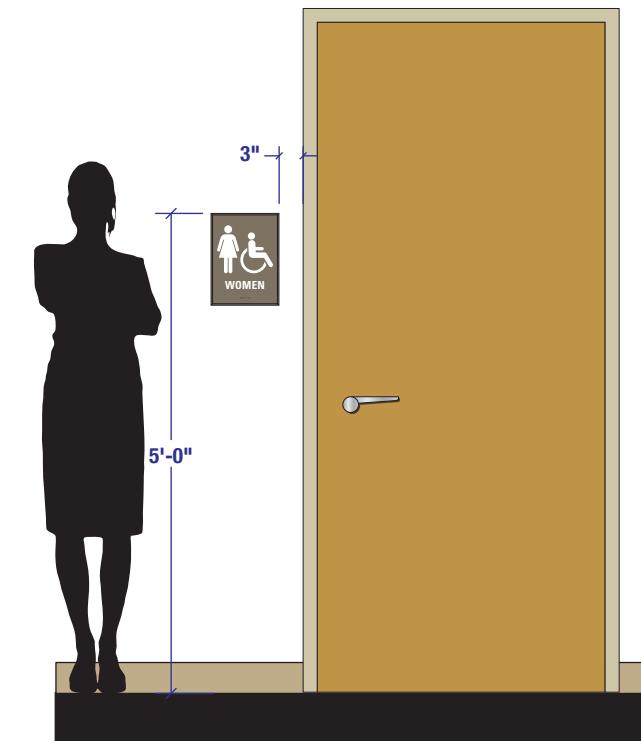

scale 1/2" = 1'-0"

Drawing Title:
**WOMEN'S RESTROOM
SIGN (PUBLIC LEVEL)**
WAYFINDING
Sign Type
RRS

UK HealthCare Pavilion A – Public Restroom Identifier (RRS)

Interior Signage | Design Intent Drawings – scale: 6"= 1'-0"

Unisex Restroom Identifier (RRS)

8.5"w x 11.5"h plaque with .125 beveled edged face panel

Overall sign is painted **SHERWIN-WILLIAMS PAINT #SW0038 LIBRARY PEWTER SATIN FINISH**

1/32" (or 1/16") raised white text

Font: Univers Std 67 Bold Condensed
(color: White)

Grade 2 Braille **SHERWIN-WILLIAMS PAINT #SW0038 LIBRARY PEWTER SATIN FINISH**

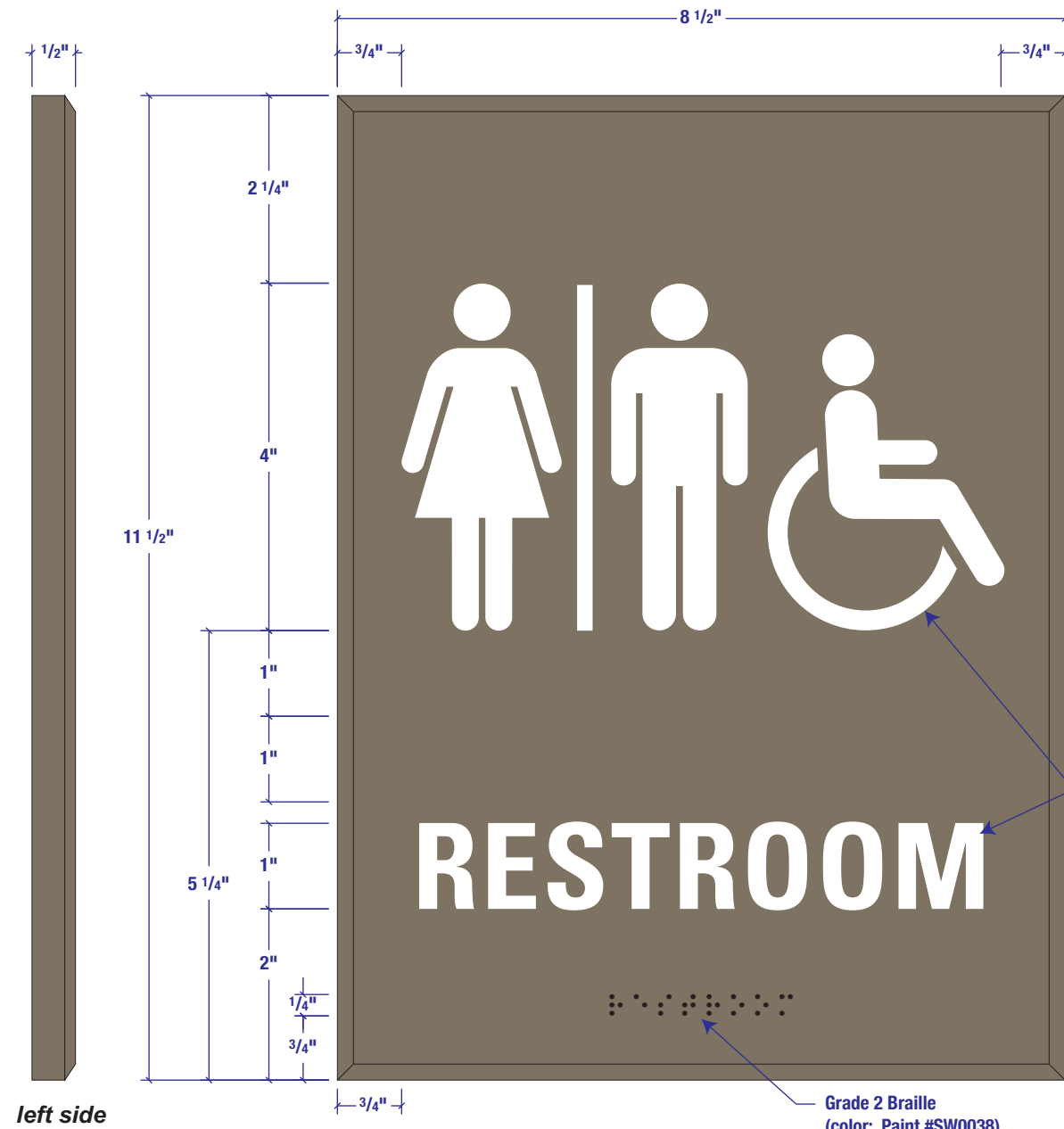

Raised 1/32" Text and Icons
Font: Univers Std
67 Bold Condensed
(color: White)

Grade 2 Braille
(color: Paint #SW0038)



Existing Campus Example

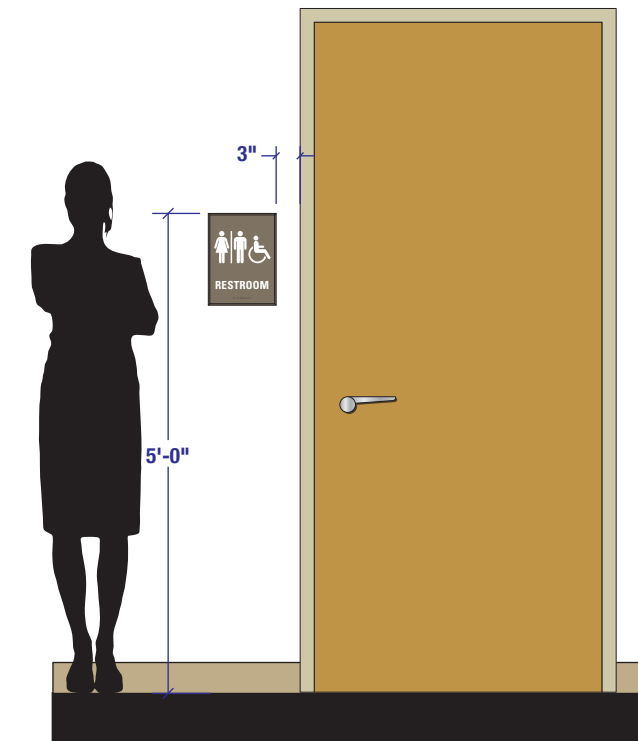

scale 1/2" = 1'-0"

| |
|--|
| Drawing Title: UNISEX RESTROOM SIGN (PUBLIC LEVEL) |
| WAYFINDING |
| Sign Type RRS |

UK HealthCare Pavilion A – Public Restroom Identifier (RRS)

Interior Signage | Design Intent Drawings – scale: 6"= 1'-0"

Staff Restroom Identifier (RRS)

8.5"w x 11.5"h plaque with .125 beveled edged face panel

Overall sign is painted **SHERWIN-WILLIAMS PAINT #SW0038 LIBRARY PEWTER SATIN FINISH**

1/32" (or 1/16") raised white text

Font: Univers Std 67 Bold Condensed
(color: White)

Grade 2 Braille **SHERWIN-WILLIAMS PAINT #SW0038 LIBRARY PEWTER SATIN FINISH**



Raised 1/32" Text and Icons
Font: Univers Std
67 Bold Condensed
(color: White)

Grade 2 Braille
(color: Paint #SW0038)



Existing Campus Example

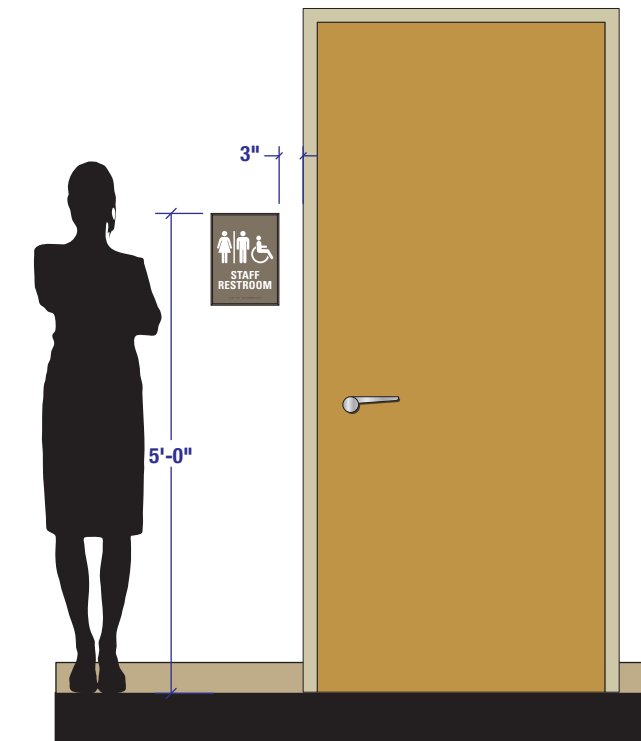

scale 1/2" = 1'-0"

| |
|---|
| Drawing Title: STAFF RESTROOM SIGN (PUBLIC LEVEL) |
| WAYFINDING |
| Sign Type RRS |

UK HealthCare Pavilion A – Public Restroom Identifier (RRS)

Interior Signage | Design Intent Drawings – scale: 6"= 1'-0"

Family Restroom Identifier (RRS)

8.5"w x 11.5"h plaque with .125 beveled edged face panel

Overall sign is painted **SHERWIN-WILLIAMS PAINT #SW0038 LIBRARY PEWTER SATIN FINISH**

1/32" (or 1/16") raised white text

Font: Univers Std 67 Bold Condensed
(color: White)

Grade 2 Braille **SHERWIN-WILLIAMS PAINT #SW0038 LIBRARY PEWTER SATIN FINISH**

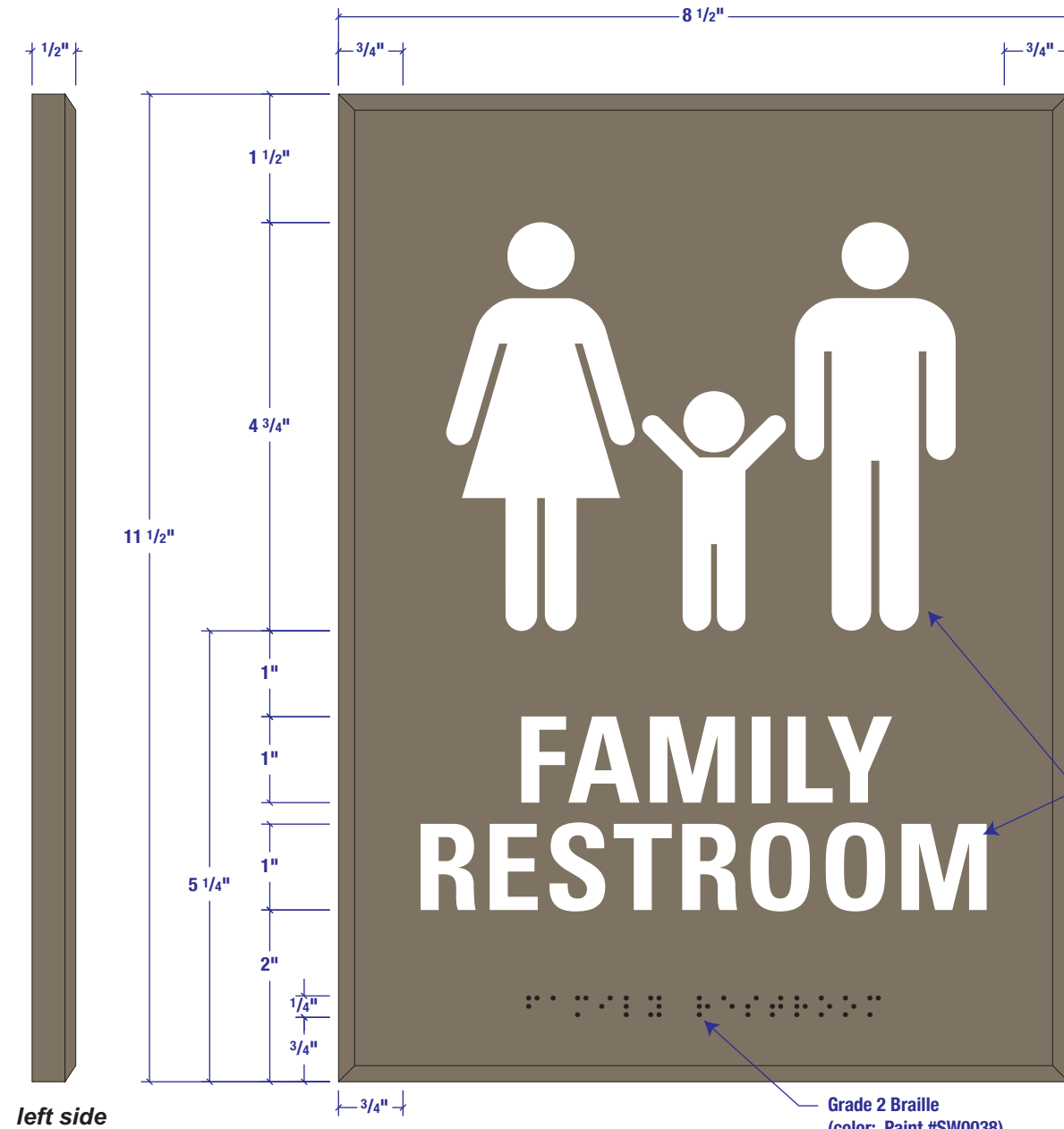

Existing Campus Example

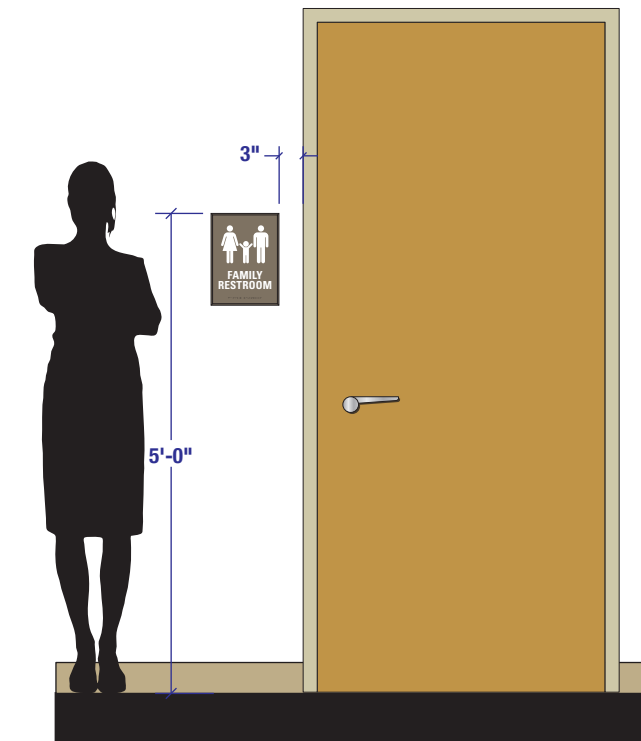

scale 1/2" = 1'-0"

| |
|--|
| Drawing Title: FAMILY RESTROOM SIGN (PUBLIC LEVEL) |
| WAYFINDING |
| Sign Type RRS |

UK HealthCare Pavilion A – Public Stairwell Signage (SWS)

Interior Signage | Design Intent Drawings – scale: 6"= 1'-0"

Stairwell Signage (SWS)

8.5"w x 11.5"h plaque with .125 beveled edged face panel

Overall sign is painted **SHERWIN-WILLIAMS PAINT #SW0038 LIBRARY PEWTER SATIN FINISH**

1/32" (or 1/16") raised white text

Font: Univers Std 67 Bold Condensed
(color: White)

Grade 2 Braille **SHERWIN-WILLIAMS PAINT #SW0038 LIBRARY PEWTER SATIN FINISH**

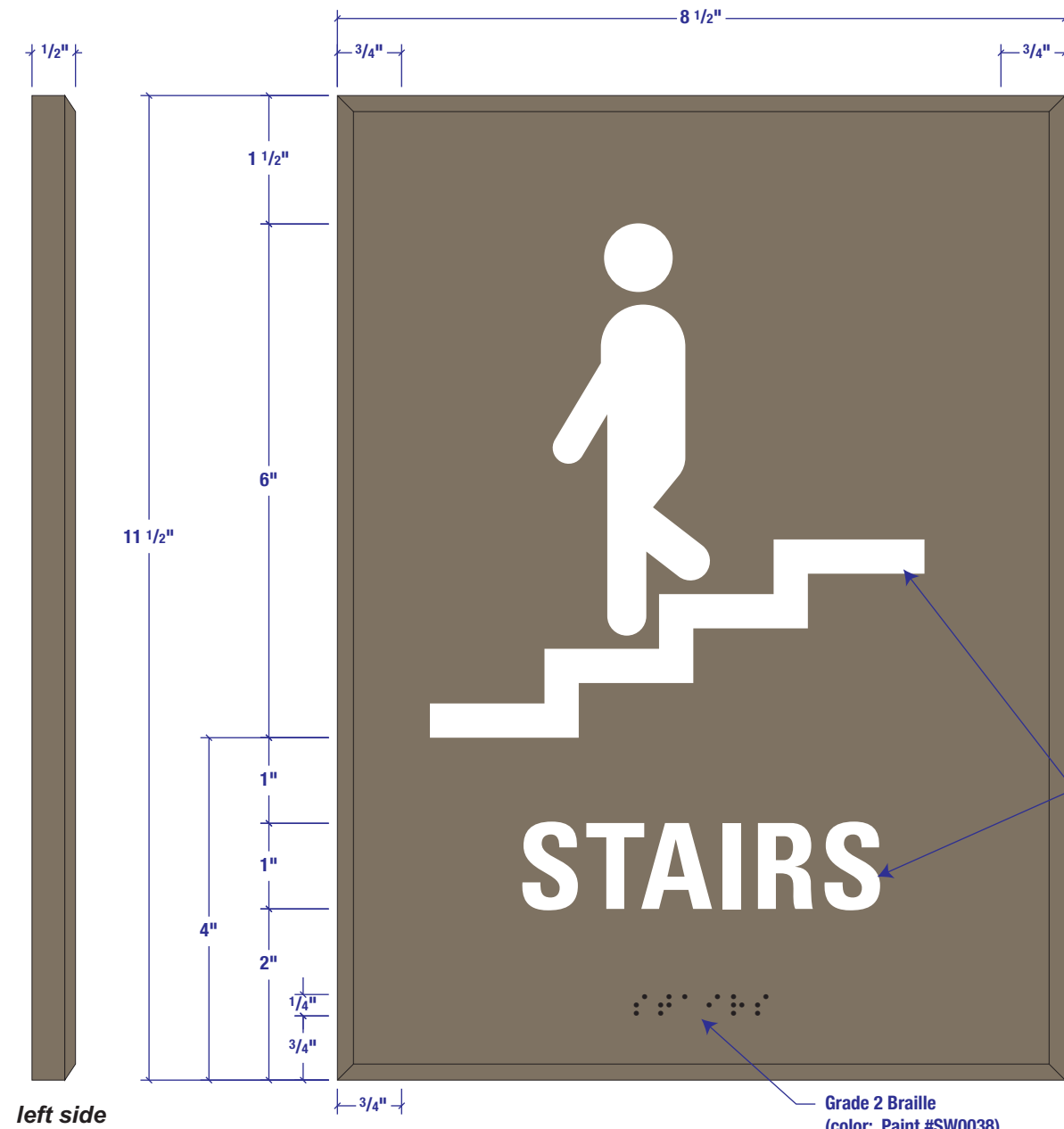

Raised 1/32" Text and Icons
Font: Univers Std
67 Bold Condensed
(color: White)

Grade 2 Braille
(color: Paint #SW0038)



Existing Campus Example

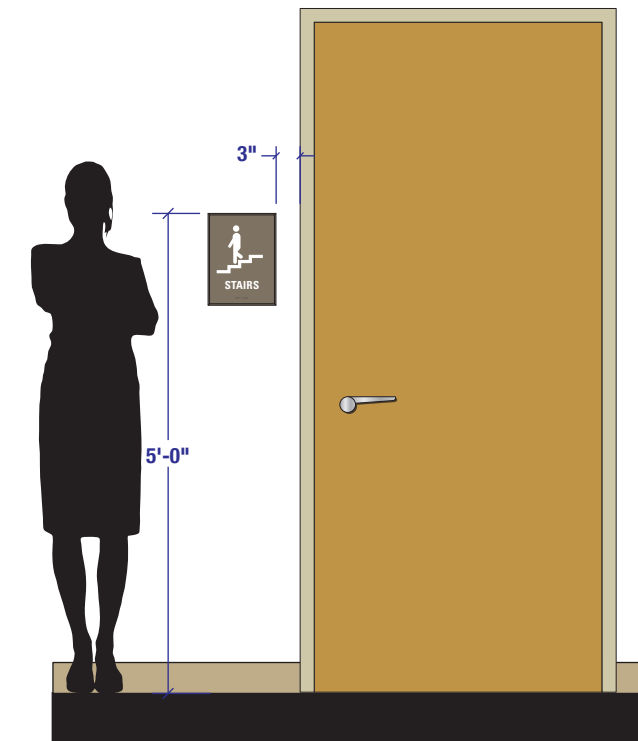

scale 1/2" = 1'-0"

| |
|--|
| Drawing Title: STAIRWELL SIGNAGE (PUBLIC LEVEL) |
| WAYFINDING |
| Sign Type SWS |

UK HealthCare Pavilion A – Back of House Restroom (SRR)

Interior Signage | Design Intent Drawings – scale: 6"= 1'-0"

Men's Restroom Identifier (SRR)

8.5"w x 11.5"h plaque

Overall sign is painted **SHERWIN-WILLIAMS PAINT #SW0038 LIBRARY PEWTER SATIN FINISH**

1/32" (or 1/16") raised white text

Font: Univers Std 67 Bold Condensed
(color: White)

Grade 2 Braille **SHERWIN-WILLIAMS PAINT #SW0038 LIBRARY PEWTER SATIN FINISH**

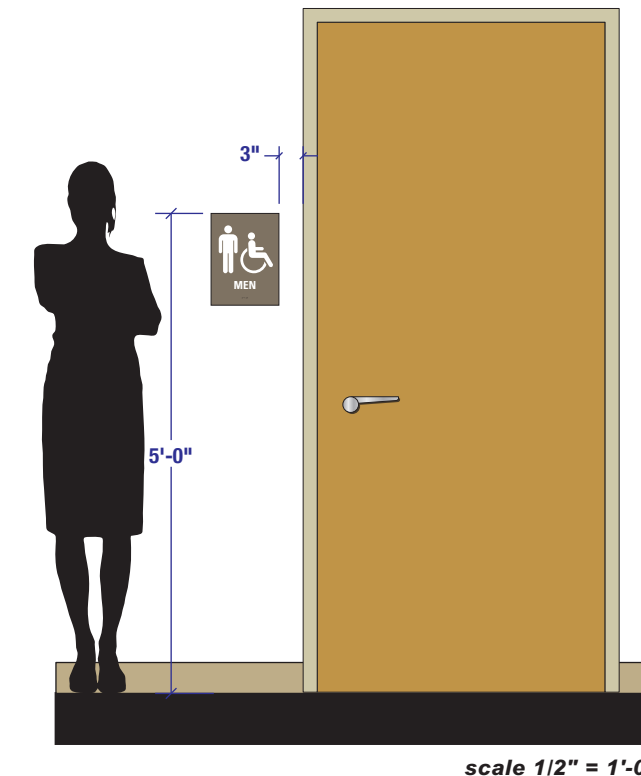
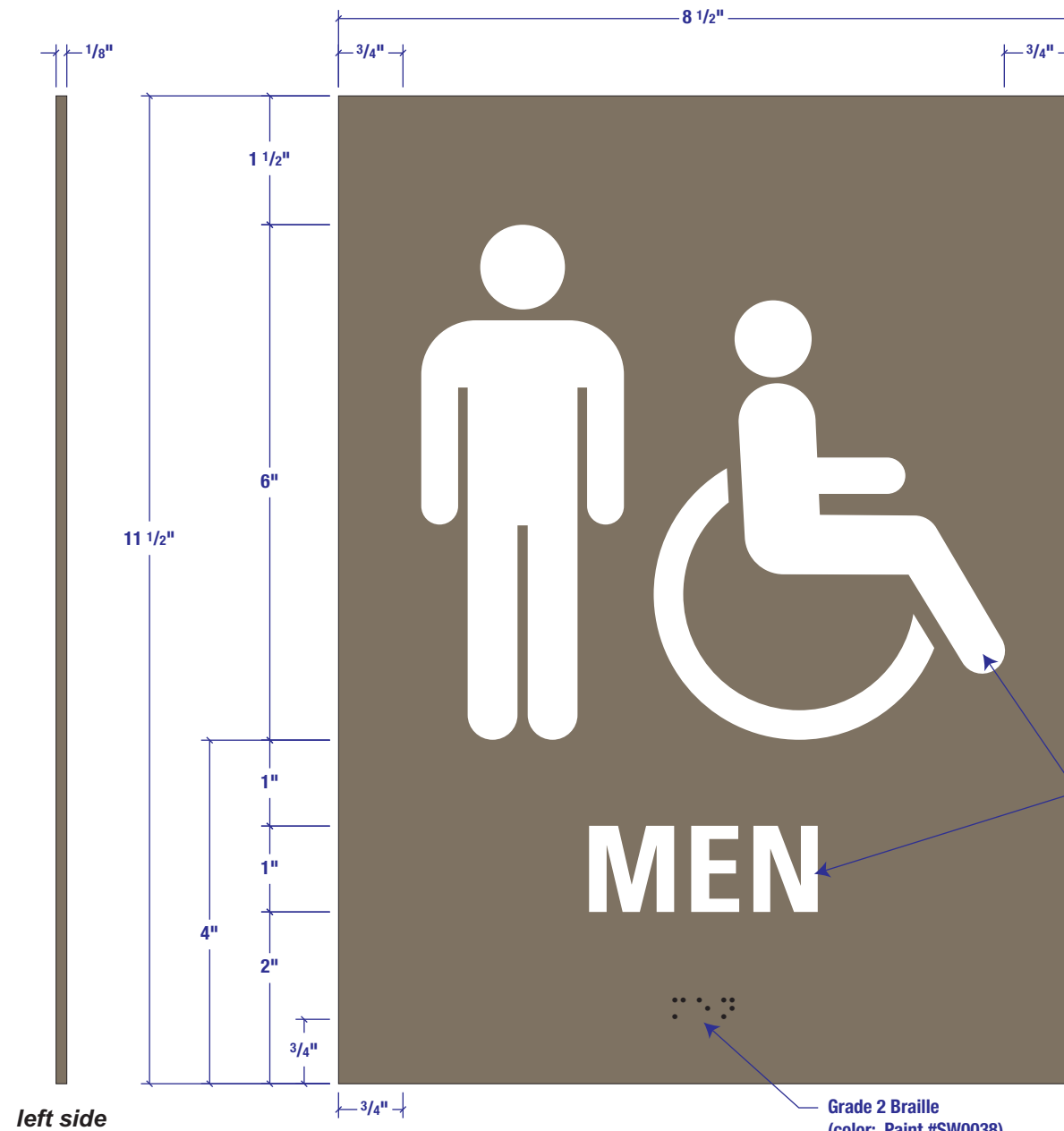

| |
|---|
| Drawing Title: MEN'S RESTROOM SIGN (BACK OF HOUSE) |
| WAYFINDING |
| Sign Type SRR |

UK HealthCare Pavilion A – Back of House Restroom (SRR)

Interior Signage | Design Intent Drawings – scale: 6"= 1'-0"

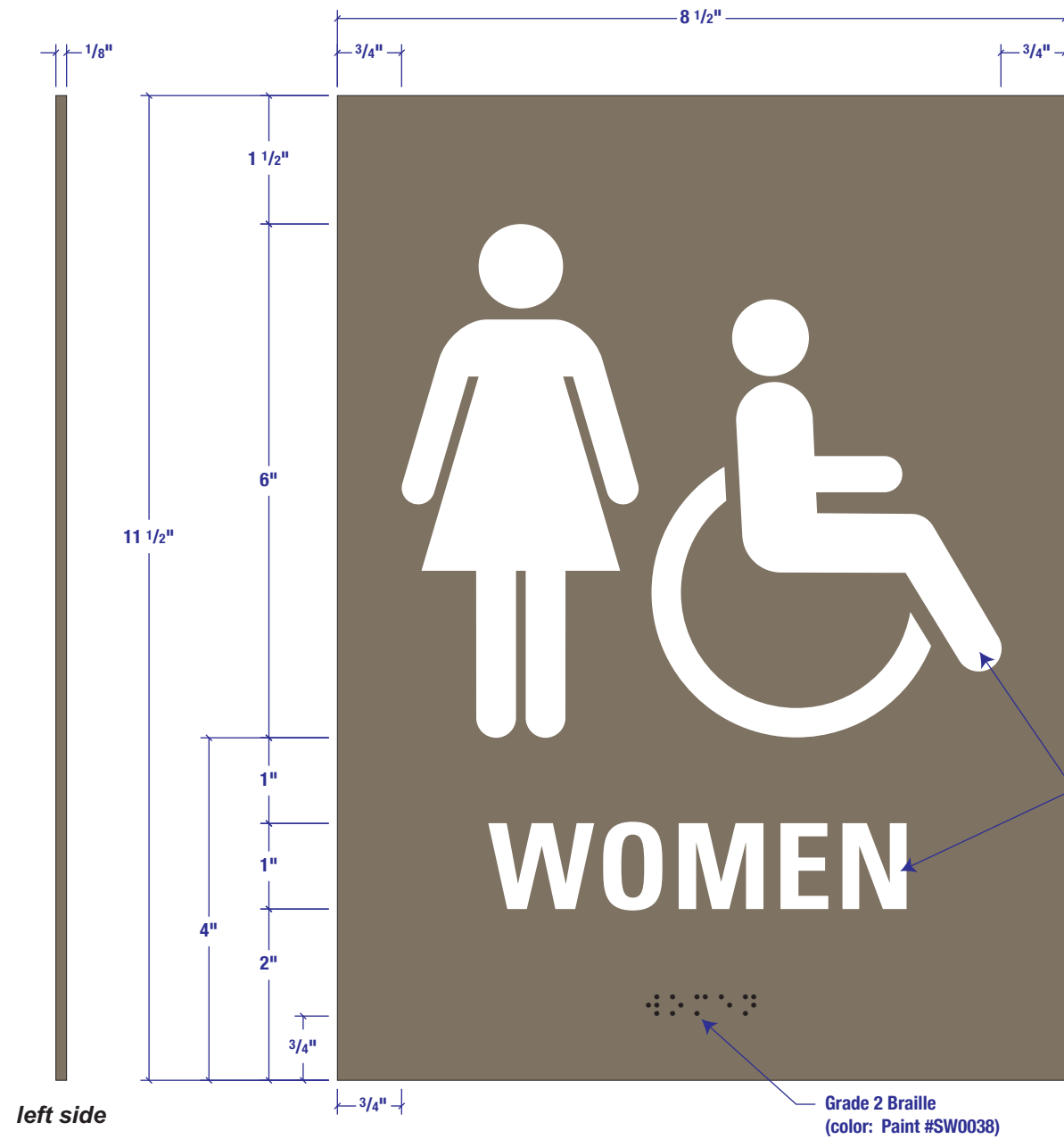

Women's Restroom Identifier (SRR)

8.5"w x 11.5"h plaque

Overall sign is painted **SHERWIN-WILLIAMS PAINT #SW0038 LIBRARY PEWTER SATIN FINISH**

1/32" (or 1/16") raised white text

Font: Univers Std 67 Bold Condensed
(color: White)

Grade 2 Braille **SHERWIN-WILLIAMS PAINT #SW0038 LIBRARY PEWTER SATIN FINISH**

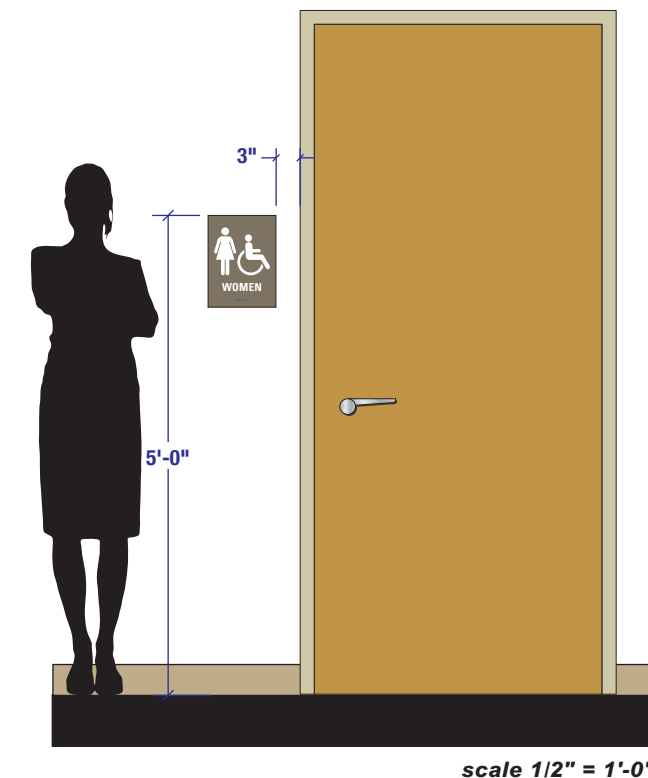

| |
|--|
| Drawing Title: WOMEN'S RESTROOM SIGN (BACK OF HOUSE) |
| WAYFINDING |
| Sign Type SRR |

UK HealthCare Pavilion A – Back of House Restroom (SRR)

Interior Signage | Design Intent Drawings – scale: 6"= 1'-0"

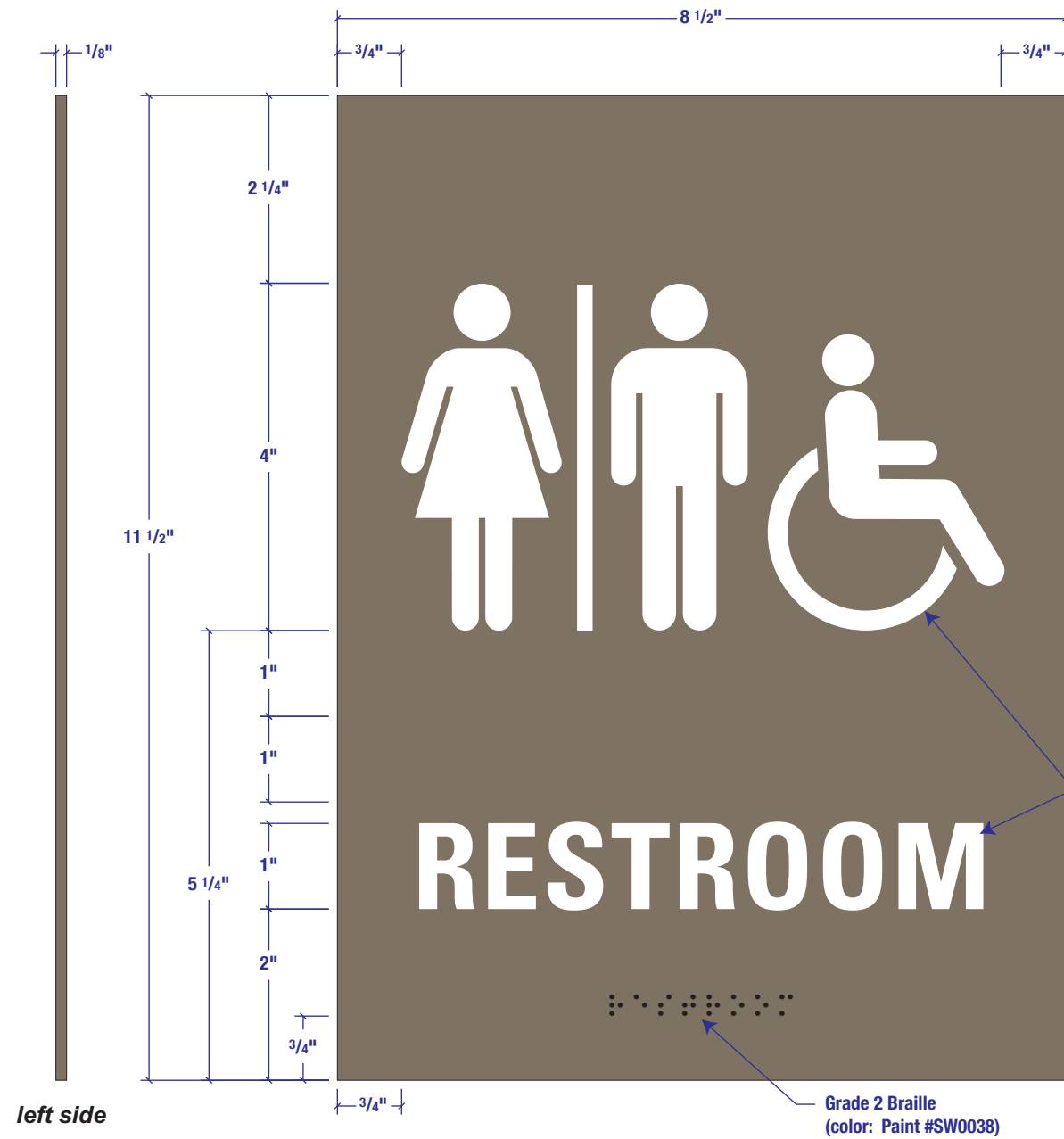

Unisex Restroom Identifier (SRR)

8.5"w x 11.5"h plaque

Overall sign is painted **SHERWIN-WILLIAMS PAINT #SW0038 LIBRARY PEWTER SATIN FINISH**

1/32" (or 1/16") raised white text

Font: Univers Std 67 Bold Condensed
(color: White)

Grade 2 Braille **SHERWIN-WILLIAMS PAINT #SW0038 LIBRARY PEWTER SATIN FINISH**



Drawing Title:
**UNISEX RESTROOM
SIGN (BACK OF HOUSE)**
WAYFINDING
Sign Type
SRR

UK HealthCare Pavilion A – Back of House Restroom (SRR)

Interior Signage | Design Intent Drawings – scale: 6"= 1'-0"

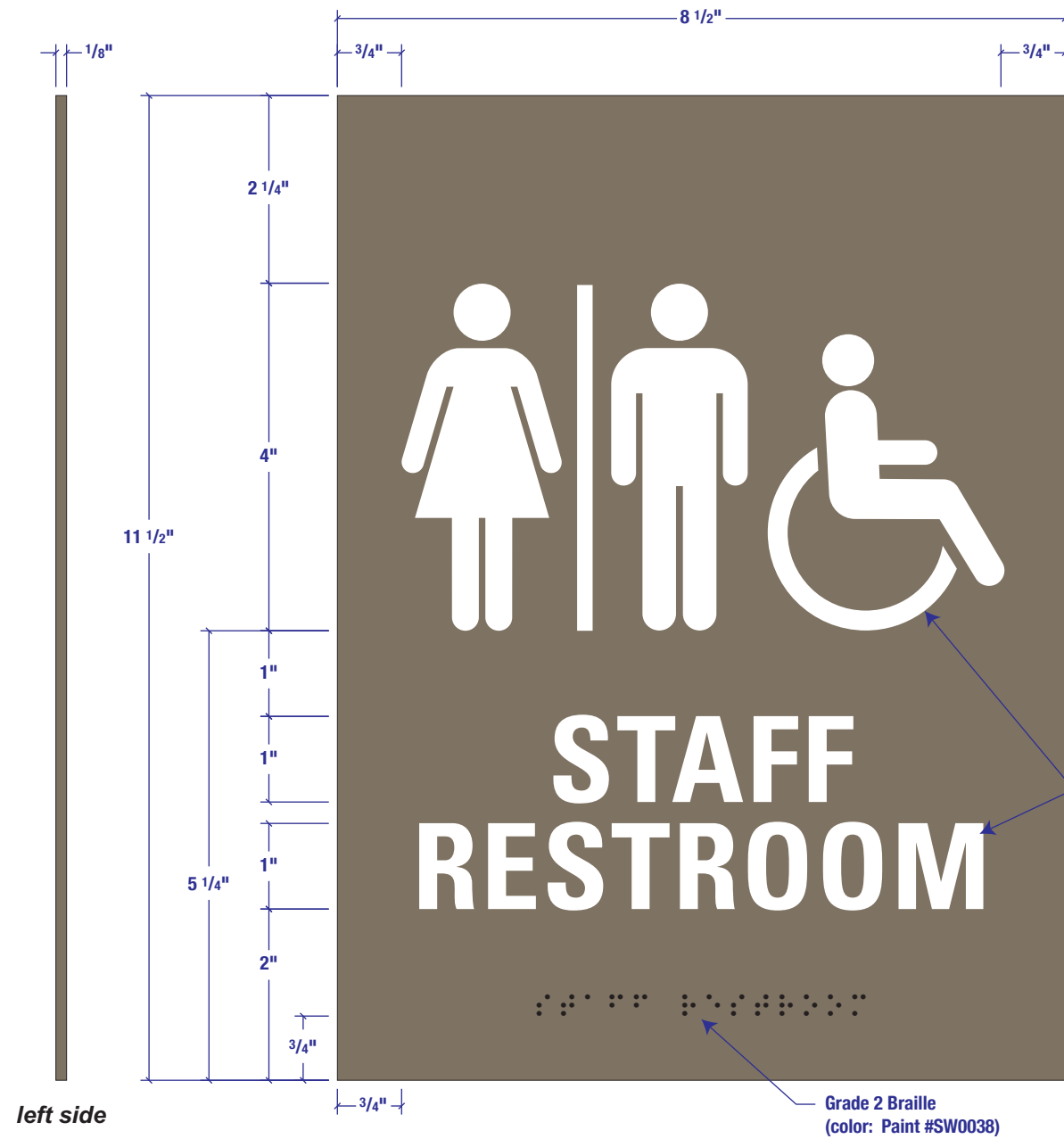

Staff Restroom Identifier (SRR)

8.5"w x 11.5"h plaque

Overall sign is painted **SHERWIN-WILLIAMS PAINT #SW0038 LIBRARY PEWTER SATIN FINISH**

1/32" (or 1/16") raised white text
Font: Univers Std 67 Bold Condensed
(color: White)

Grade 2 Braille **SHERWIN-WILLIAMS PAINT #SW0038 LIBRARY PEWTER SATIN FINISH**

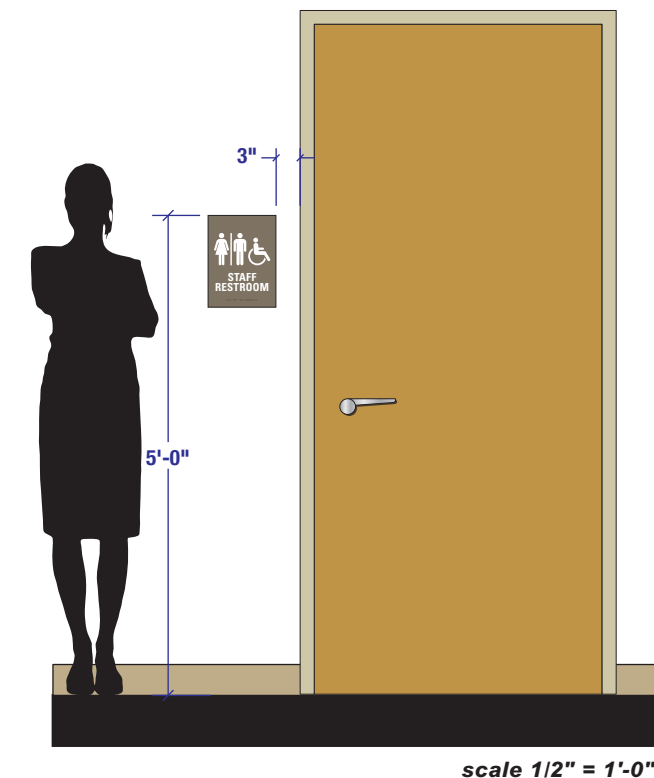

| |
|---|
| Drawing Title: STAFF RESTROOM SIGN (BACK OF HOUSE) |
| WAYFINDING |
| Sign Type SRR |

UK HealthCare Pavilion A – Back of House Room Identifier (SRI)

Interior Signage | Design Intent Drawings – scale: 6"= 1'-0"

Back of House Room Identifier (SRI)

8.5"w x 4"h plaque

Overall sign is painted **SHERWIN-WILLIAMS PAINT #SW0038 LIBRARY PEWTER SATIN FINISH**

1/32" (or 1/16") raised white text

Font: Univers Std 67 Bold Condensed
(color: White)

Grade 2 Braille **SHERWIN-WILLIAMS PAINT #SW0038 LIBRARY PEWTER SATIN FINISH**

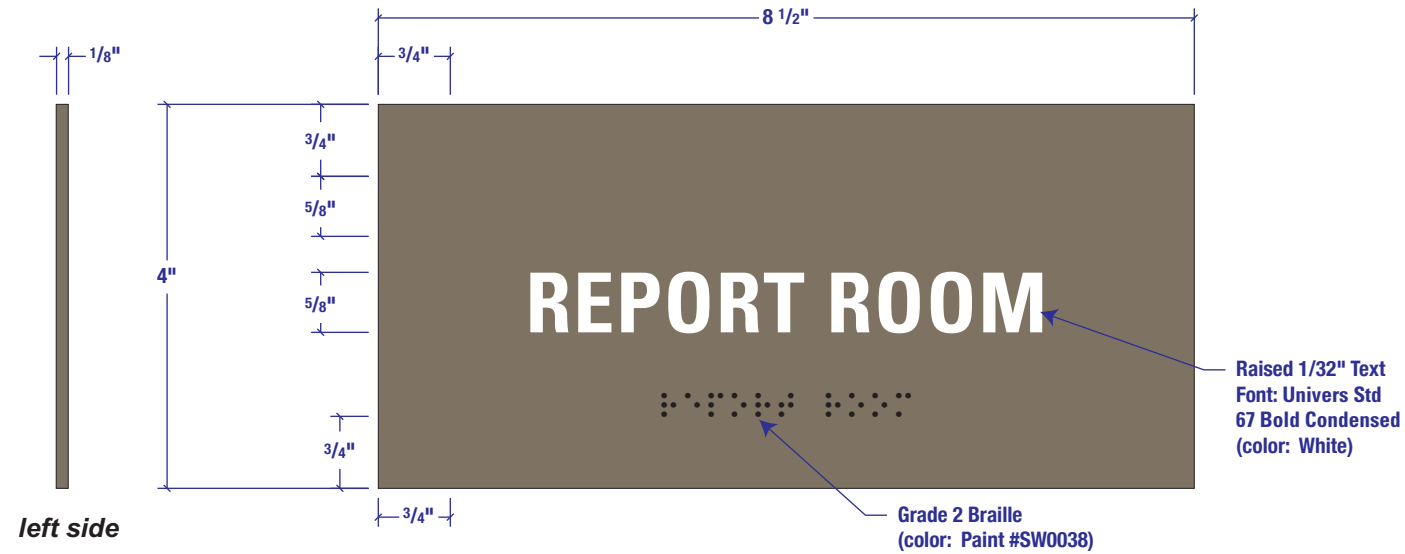

Existing Campus Example

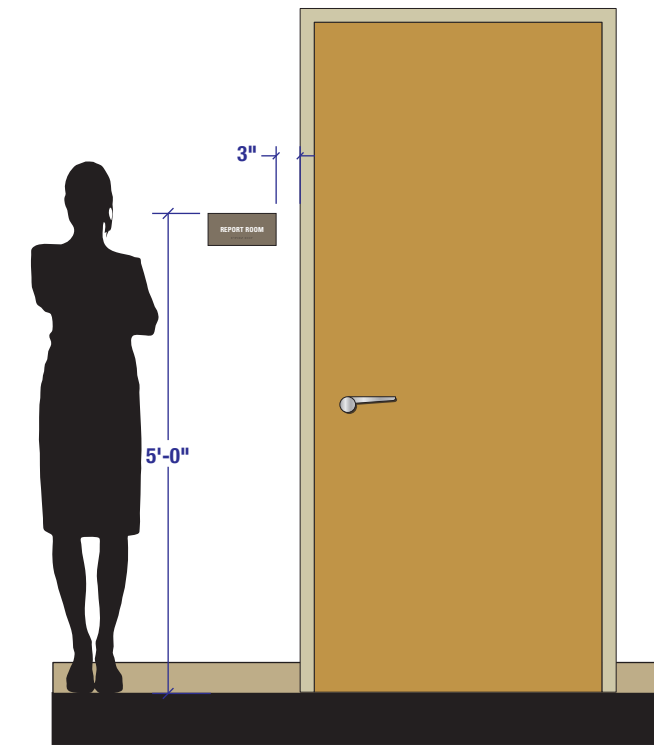

scale 1/2" = 1'-0"

| |
|--|
| Drawing Title: SERVICE LEVEL ROOM IDENTIFIER (BACK OF HOUSE) |
| WAYFINDING |
| Sign Type SRI |

UK HealthCare Pavilion A – Door Tag (DT)

Interior Signage | Design Intent Drawings – scale: 1"= 1"

Door Tag (DT)

4"w x 1"h plaque

Overall sign is painted **SHERWIN-WILLIAMS PAINT #SW0038 LIBRARY PEWTER SATIN FINISH**

Silk screened white text
Font: Univers Std 67 Bold Condensed
(color: White)

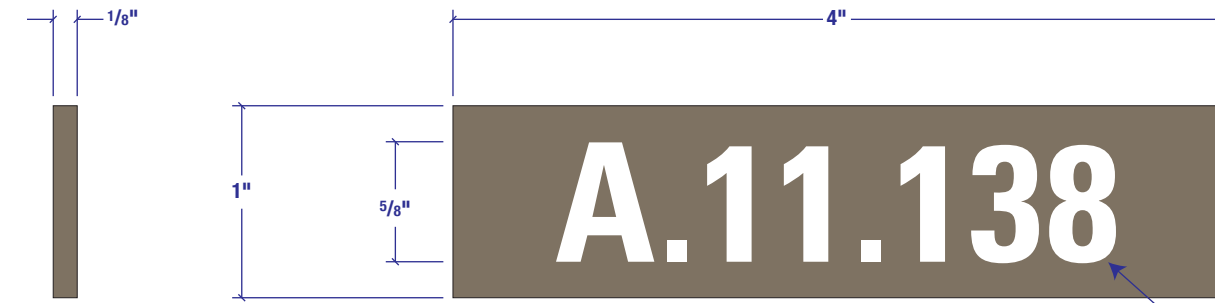

left side

Silk Screened Text
Font: Univers Std
67 Bold Condensed
(color: White)



Existing Campus Example

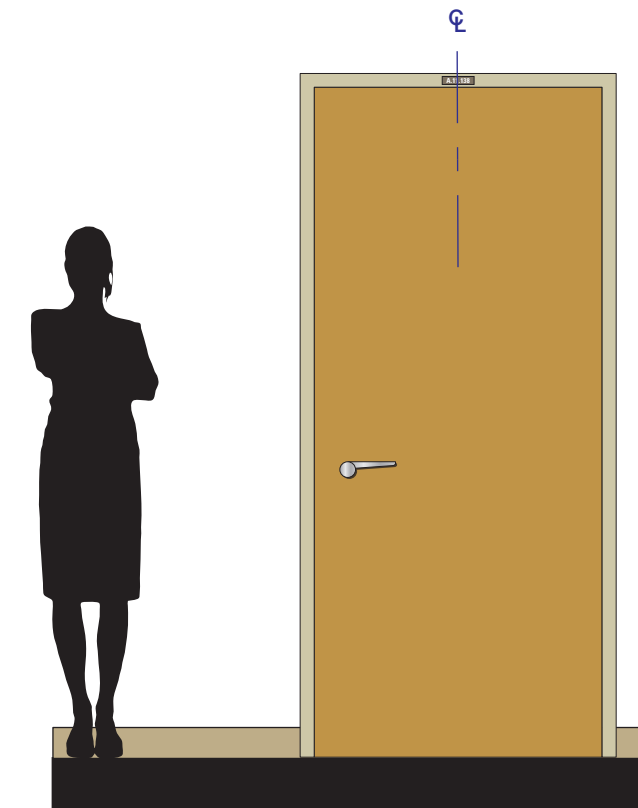

scale 1/2" = 1'-0"

| |
|---|
| Drawing Title: DOOR TAG (PUBLIC & BACK OF HOUSE) |
| WAYFINDING |
| Sign Type DT |